



2014 - 2015



*Sport Optics*





# Bring REAL to Life

Imagine feeling the natural power of life.

The sharp, clear image in the entire field of view brings nature's vibrant colours right to you.

Revel in the sensation of truly being there, thanks to Nikon's technology.

This is excitement you've never before experienced,  
the pure joy of discovering the "real" in its genuine colours.







# Why Nikon?



## **Exacting precision across a full spectrum of optical technologies**

Widely acknowledged as the global leader in precision optics, Nikon's roots go back to the development of our first binoculars in 1917. Since then, Nikon has continued to build on the knowhow of generations of optical and precision technology experts with an enduring passion for quality and innovation. Day in and day out, our products are tested in the world's most demanding environments. Using Nikon cameras and NIKKOR lenses, photographers around the globe capture moments that no one could otherwise envision. While Nikon engineers of semiconductor-manufacturing equipment employ our optics to create the world's most precise instrumentation. For Nikon, delivering a peerless vision is second nature, strengthened over the decades through constant application. At Nikon Sport Optics, our mission is not just to meet your demands, but to exceed your expectations.

## **Our commitment to deliver proven, superior products**

Nikon has come up with a simple rule for designing and developing our sport optics products: apply the best materials, the strictest quality controls, the most environment-sustaining engineering and superior lens coating technologies to achieve the very finest

optics. The benefits of this pledge have never been clearer. Maximum light transmission, superior resolution and better-defined contrast are balanced to perfection, free of aberration, in every stunning view. Because at the heart of each optical system is an invincible integrity that makes it what it is — a Nikon.

## **Large, diverse lineup to meet your every viewing need**

Viewing distant subjects up-close with sport optics can be an exhilarating experience. The optimum experience remains a subjective one, however, with countless variables. That's why Nikon offers the most extensive line of binoculars and scopes on the market. Whether your aim is serious birdwatching, stargazing, professional sea navigation, mountaineering, nature watching, travel, the theatre, or just weekend fun, there's a Nikon Sport Optics model designed to meet your needs. And our ongoing collaboration with other Nikon technologies adds even further to your viewing excitement, letting you capture those precious moments with the Nikon Digiscoping System, for example, or measure distances with speed and ease using one of our laser rangefinders. Read on and discover the tools that can help you live life larger.





# Binocular basics

## Performance factors

Nikon offers an extensive lineup of binoculars — including several of the world’s most popular series — for a diverse range of applications. Each model features various technical specifications that can help you in making the right selection. Magnification is usually considered most important, but field of view, brightness, ease of handling (weight, feel, ergonomics), suitability for eyeglass wearers and overall construction should also be taken into account.

## Magnification

Magnification, represented by a numerical value, is the relationship between a subject’s actual proportions and its magnified size. With 7x magnification, for example, a subject 700 metres distant appears as it would when viewed from 100 metres with the naked eye. As a rule, magnifications of 6x to 10x are recommended for handheld outdoor use. With magnifications of 12x or greater, any shaking by hand movement is more likely to create an unstable image and uncomfortable viewing.

## Field of view

All binoculars use number codes to designate various specifications. In “8x40 8.8°”, for example, “8.8°” represents the *real* field of view, which is the angle of the viewing field measured from the central point of the objective lens. The *apparent* field of view, on the other hand, conveys how wide that field of view appears to the naked eye. The real field of view at 1,000 metres listed in the specifications is the width of the visible area at a distance of 1,000 metres.

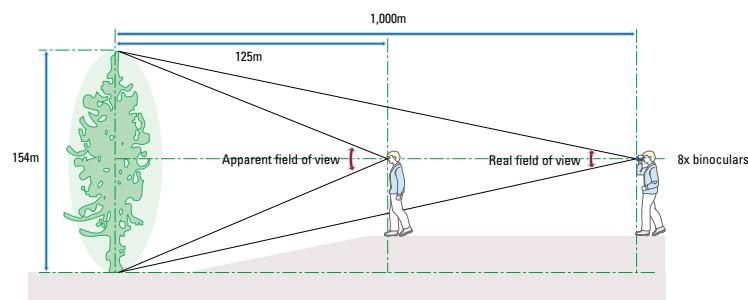

\* Apparent field of view is calculated based on the ISO 14132-1:2002 standard. For details, see p 54.

## Objective lens diameter

The objective lens diameter, combined with the quality of lens and prism coatings, determines the amount of light gathered to form an image. If you are regularly observing in poor light conditions, such as early dawn or dusk, or in forested areas, you may need a larger objective lens. But large-diameter objective lenses make binoculars heavier, so 50mm is the general limit for handheld use.

## Exit pupil

The exit pupil is the image formed by the eyepiece lenses. The diameter of the exit pupil (in mm) is the effective aperture divided by the magnification. The diameter of the human eye pupil varies from 2-3mm in daylight to 7mm in the dark. An exit pupil of 7mm gives maximum light to the dilated eye and is ideal for use in the twilight and at night.

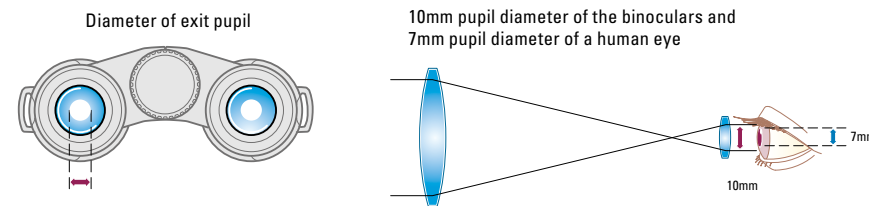

## Brightness

The relative brightness value is obtained by squaring the diameter of the exit pupil. The greater the relative brightness, the brighter the image will be. However, this value does not correspond exactly to increases in brightness viewed with the naked eye because light coming through the binoculars is 100% effective only if the exit pupil is the same diameter as the pupil of the eye.

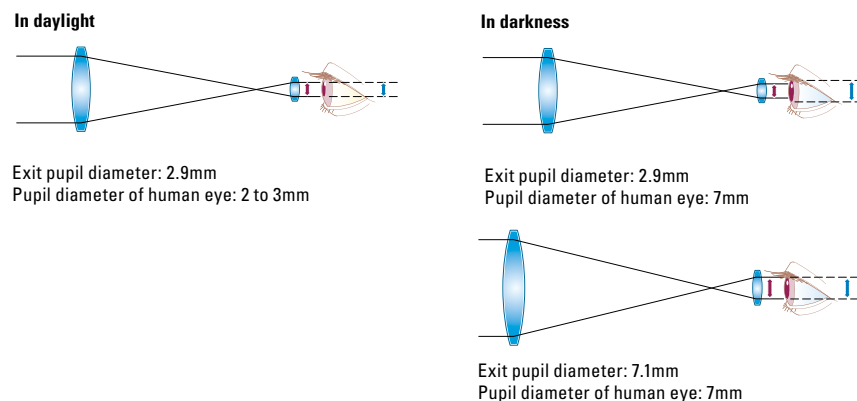

## How to read the numerical information code for binoculars

All Nikon binoculars are designated with a numerical formula, such as “10x25 5.4°”. The value “10x” indicates the magnification of the binoculars. If a person uses 10x binoculars to observe a wild bird from a distance of 100 metres, for example, it will appear to the observer as if he or she were viewing the bird from a distance of 10 metres (100 divided by 10 equals 10) with the naked eye. The next number, “25”, tells you that the effective diameter of the objective lens is 25mm. The greater the diameter of the objective lens, the brighter your image will be with the same illumination. (Nikon’s superior lens coatings also play a vital role in improving lens brightness.) If the objective lens is too large, however, the binoculars will be heavy and may cause trembling of the hands. Finally, the number “5.4°” represents the real field of view of the binoculars. This is the angle of the visible field, as measured from the centre of the objective lenses. The bigger the value, the easier it is to locate an object. Understanding the meaning of these numbers should provide you with greater freedom in selecting and using binoculars.

## Check the letters in the name of any Nikon binoculars — they convey helpful information about each model.

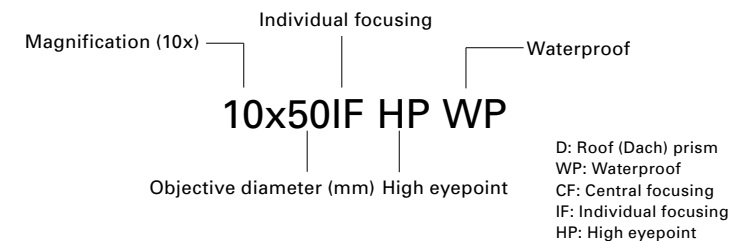

## The following icons indicate the purpose for which each series is best suited:



### Outdoors, camping, hiking

Rugged outdoor activities demand portability and durability. Models that also feature rubber armouring and waterproofing are ideal when you're up against the elements. For early morning and evening use, binoculars with a large objective diameter and Nikon's multicoated lenses are recommended.



### Birdwatching, nature watching

Binoculars with a wide field of view and 7x to 10x magnification are suited for general nature viewing. Observing whales or birds at a greater distance is more comfortable with 8x to 12x magnification models. For even closer views, Fieldscopes are recommended.



### Marine sports, fishing

Waterproofing and durability are essential for these activities. Enhanced brightness and a wide field of view are desirable, too. Models that feature vibration reduction are favoured for on-board use.



### Spectator sports

Binoculars that feature a wide field of view and 7x to 10x magnification are handy for fast-moving sports. Zoom-type binoculars are convenient, too, enabling quick and easy changes in magnification to suit the viewing situation.



### Travelling

Compact, lightweight models with midrange magnification and field of view are ideal for travelling.



### Theatre

Compact models with magnification of 4x to 8x are recommended for theatre and concert use. To focus on a particular performer, 7x to 10x models are more appropriate.



### Stargazing

Astronomical observation requires a bright optical system with a large objective diameter and exit pupil. Waterproof and aberration-corrected binoculars are preferred.



### Museum

In museums, compact, lightweight models with low magnification and a close focusing distance of less than 2m are recommended.



### For eyeglass wearers





Choose a long eye relief (high eye point) design so that eyeglass wearers can also enjoy a full, clear field of view.

## Table of contents





### Binoculars pp 9 - 27

	<b>EDG</b>	pp 10 - 11
	<b>MONARCH</b>	pp 12 - 13
	<b>PROSTAFF</b>	pp 14 - 15
	<b>ACULON</b>	pp 16 - 19
	<b>High Grade</b>	pp 20 - 21
	<b>Elegant Compact</b>	p 22
	<b>Compact</b>	p 23
	<b>Marine</b>	pp 24 - 25
	<b>Standard</b>	p 25
	<b>The Standard for Advanced Nature Observation</b>	p 26
	<b>StabilEyes</b>	p 27



### Fieldsopes pp 29 - 35

	<b>EDG</b>	pp 30 - 31
	<b>PROSTAFF</b>	pp 32 - 33
	<b>ED50/ED50 A</b>	p 33
	<b>Nikon Digiscoping System</b>	pp 34 - 35

### Laser Rangefinders pp 36 - 43

	<b>COOLSHOT</b>	pp 37 - 38
	<b>PROSTAFF</b>	pp 40 - 41
	<b>ACULON</b>	p 41
	<b>Laser 1000A S/Laser 1200S</b>	p 42
	<b>Forestry Pro</b>	p 43

### Exceptional Optics for Specialised Needs pp 44 - 47

	<b>Binocular Telescope</b>	p 45
	<b>Loupes</b>	p 46
	<b>Fieldmicroscopes</b>	p 47

### Technical Data pp 48 - 59

# Binoculars

## Up-close and real

Nikon binoculars have established a benchmark for extraordinary value in Sport Optics. Building on Nikon's eminence as the global leader in precision optics, we provide binoculars for diverse applications, making it easy to select fine, brilliant optics that are ideal for your own particular needs.





## Experience the extraordinary

The EDG brand was born of Nikon's commitment to provide a premium lineup of the finest instruments in the field of sport optics. In combination with Nikon's many leading-edge technologies, including both optical and mechanical, these exceptional products are able to deliver a spectacular field of view, and performance that goes beyond the nature and outdoor enthusiast's wildest dreams.

**EDG 8x32/10x32**  
**EDG 7x42/8x42/10x42**



EDG 10x42

- Nikon's legendary ED (Extra-low Dispersion) glass lenses**  
 Nikon's legendary ED (Extra-low Dispersion) glass lenses effectively compensate for chromatic aberrations to provide images of superior contrast and outstanding resolution.

- Field-flattener lens system**  
 Nikon's field-flattener lens system minimises curvature of field — aberrations that occur when focusing on the centre of the field of view causing the periphery to go out of focus and vice versa — and delivers sharper, clearer images all the way to the lens periphery.

- Dielectric high-reflective multilayer prism coating**  
 Dielectric high-reflective multilayer coating is applied to a roof prism unit that does not feature total internal reflection. This boosts light reflectivity of more than 99% (designed value) for the full visible range, giving you clearer whites and a sharper, brighter, more natural vision across the entire field of view.

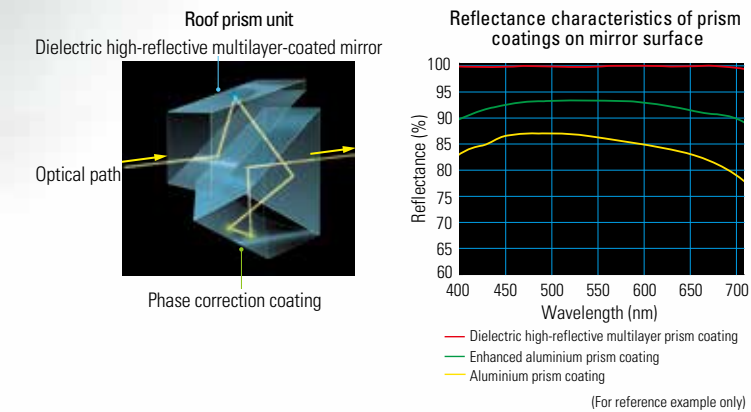

- Phase correction coating**  
 Phase shift of light is caused by phase differences arising from total light reflection on a roof (Dach) surface. Phase-correction coating is applied to the surface to minimise loss of resolution, ensuring high-contrast images.

- Brighter images, even at twilight**  
 Advanced multilayer coating is applied to all lenses and prisms to increase light transmission and to reduce flare and ghosting for super-bright, razor-sharp images, even at dawn and dusk.

- Eco-glass optics, environmentally safe materials**  
 All lenses and prisms are free of lead and arsenic.

- Dual focus knob with dioptre adjustment**  
 Larger focus knob for easy operation. Pull out to adjust dioptre (left), push in to focus (right).



- Turn-and-slide rubber eyecups facilitate easy positioning of eyes at the correct eyepoint**  
 For non-eyeglass wearers, use the eyecups in the extended position. For eyeglass wearers, use them fully retracted. Eyecups can be adjusted to any of four click stops, offering fine adjustment that meets your needs.

- Long eye relief design for a clear field of view, even for eyeglass wearers**

- Horn-shaped detachable eyecups**  
 Ergonomically designed horn-shaped eyecups block peripheral light to give you a clearer field of view.



- Comfortable, ergonomically designed strap**  
 Designed for comfort, even during long days of use. The strap length is easily adjusted without having to remove it from your neck.



- Short bridge style for easy grip**

- Durable design**  
 Sturdy, lightweight die-cast magnesium alloy body.

- Waterproof (up to 5m/16.4 ft. for 10 minutes)**  
 Waterproof/fogproof construction features a nitrogen-filled body with O-ring seals.



EDG 8x32



EDG 8x42



# MONARCH

## A royal invitation to the magnificence of nature

Decades of design experience and expertise have made Nikon a leading force in nature watching and enjoyment. Advanced technology, evidenced by an amazingly bright and sharp field of view, gives lovers of the outdoors the chance to observe nature in all its spectacular glory and treasure each vivid and captivating moment. This unique heritage has led to the widely acclaimed reliable performance of MONARCH binoculars.

MONARCH 7 8x30



## MONARCH 7

MONARCH 7 8x30/10x30/8x42/10x42



### Exquisite optical performance in a compact body delivering a wide field of view

- Sophisticatedly compact, exterior design
- Extra-low dispersion (ED) glass for chromatic aberration compensation and clearer viewing
- Wide apparent field of view
- Dielectric high-reflective multilayer prism coating ensures superior transmittance uniformity across the visible range resulting in brighter images and more natural colours
- All lenses and prisms are multilayer-coated for bright images
- Scratch-resistant coating is applied to the outside surfaces of objective and eyepiece lenses (8x42, 10x42 only)
- Phase-correction-coated roof prisms for high resolution
- Long eye relief design ensures a clear field of view, even for eyeglass wearers
- Eco-glass optics that are free of lead and arsenic are used for all lenses and prisms
- Waterproof (up to 1m/3.3 ft. for 10 minutes) and fog-free with O-ring seals and nitrogen gas
- Turn-and-slide rubber eyecups with multi-click facilitate easy positioning of eyes at the correct eyepoint
- Rubber armouring for shock resistance and a firm, comfortable grip
- Lightweight body uses fibreglass-reinforced polycarbonate resin
- Soft-to-the-touch neck strap
- Flip-down objective lens cap



MONARCH 7 10x30



MONARCH 7 8x42



MONARCH 5 10x42



MONARCH 5 16x56

## MONARCH 5

MONARCH 5 8x42/10x42/12x42/8x56/16x56/20x56



### Exceptional image quality realised with ED glass and dielectric high-reflective multilayer prism coating

- Extra-low dispersion (ED) glass for chromatic aberration compensation and clearer viewing
- Dielectric high-reflective multilayer prism coating ensures superior transmittance uniformity across the visible range resulting in brighter images and more natural colours
- All lenses and prisms are multilayer-coated for bright images
- Phase-correction-coated roof prisms for high resolution
- Long eye relief design ensures a clear field of view, even for eyeglass wearers
- Eco-glass optics that are free of lead and arsenic are used for all lenses and prisms
- Waterproof (up to 1m/3.3 ft. for 10 minutes) and fog-free with nitrogen gas
- Turn-and-slide rubber eyecups with multi-click facilitate easy positioning of eyes at the correct eyepoint
- Rubber armouring for shock resistance and a firm, comfortable grip
- Lightweight body uses fibreglass-reinforced polycarbonate resin
- Soft-to-the-touch neck strap
- Flip-down objective lens cap
- Tripod adaptor is a supplied accessory for 16x56 and 20x56 models

# PROSTAFF



## The world on your terms

Discovery is a way of life for you. You prefer to enter and explore new worlds with optical equipment sporting the latest breakthroughs in both value and performance. This approach enables you to better appreciate what you discover. Welcome to the wonderful world of PROSTAFF. Expect solid, honest-to-goodness performance you can rely on.

PROSTAFF 7S 8x30

## PROSTAFF 7s

PROSTAFF 7s 8x30/10x30/8x42/10x42



### Achieving high-quality performance in a stylish body

- All lenses and prisms are multilayer-coated for bright images
- Phase-correction-coated roof prisms for high resolution
- High-reflection mirror-coated prisms for bright images
- Long eye relief design ensures a clear field of view, even for eyeglass wearers
- Turn-and-slide rubber eyecups with multi-click facilitate easy positioning of eyes at the correct eyepoint
- Waterproof (up to 1m/3.3 ft. for 10 minutes) and fog-free with nitrogen gas
- Rubber armouring for shock resistance and a firm, comfortable grip
- Lightweight body uses fibreglass-reinforced polycarbonate resin
- Eco-glass optics that are free of lead and arsenic are used for all lenses and prisms



PROSTAFF 7S 10x42

PROSTAFF 7S 8x30

## PROSTAFF 5

PROSTAFF 5 8x42/10x42/10x50/12x50



### Sleekly designed, performance-packed model

- Multilayer-coated lenses for bright images
- Long eye relief design ensures a clear field of view, even for eyeglass wearers
- Turn-and-slide rubber eyecups with multi-click facilitate easy positioning of eyes at the correct eyepoint
- Waterproof (up to 1m/3.3 ft. for 10 minutes) and fog-free with nitrogen gas
- Rubber armouring for shock resistance and a firm, comfortable grip
- Lightweight body uses fibreglass-reinforced polycarbonate resin
- Eco-glass optics that are free of lead and arsenic are used for all lenses and prisms



PROSTAFF 5 8x42

PROSTAFF 5 10x50



# ACULON

## Taking it all in, in your own unique style

For you, just as important as observing the world is looking at it in your own way. That means through binoculars designed for the way you live. You know there is a wonderful world out there full of colours and you want to witness it in the style you are accustomed to. ACULON binoculars are for you — with a sporty design in a variety of styles and colours that suit your mood and the occasion. If you prefer sport optics that complement your personality, ACULON is the way to go.



### ACULON T01 8x21/10x21



#### Expand your world with this stylish compact

- Compact and lightweight for portability — weighing a mere 195g
- Multilayer-coated lenses for bright images
- Larger focusing ring for smooth operation
- Turn-and-slide rubber eyecups facilitate easy positioning of eyes at the correct eyepoint
- Single-hinged, slim and stylish design
- Available in five body colours: 8x21 in orange, blue and white/10x21 in black and red

ACULON T01 8x21 <Orange>



ACULON T01 8x21 <Blue>



ACULON T01 10x21 <Red>



ACULON T01 8x21 <White>



ACULON T01 10x21 <Black>





**ACULON T51** 8x24/10x24



**Sophisticated elegance for wherever you go**

- Slim, compact and lightweight body
- Elegant, sophisticated exterior design with metallic, smooth-to-the-touch finish
- Multilayer-coated lenses for bright images
- Close focusing distance: 2.5m
- Eco-glass optics are free of lead and arsenic
- Four alluring colour variations: 8x24 in black, silver, pink and red/10x24 in black and silver



ACULON T51 8x24 <Pink>



ACULON T51 8x24 <Red>



ACULON T51 10x24 <Black>



ACULON T51 10x24 <Silver>

**ACULON T11** 8-24x25



**Sleek and compact binoculars with 3x zoom capability in four colours**

- Compact and lightweight
- All lenses and prisms are multilayer-coated for bright images
- Unique zoom lever designed for extra-smooth 8-24x zooming
- Turn-and-slide rubber eyecups facilitate easy positioning of eyes at the correct eyepoint
- Designed for comfortable fit and easy handling
- Available in four body colours (black/red/blue/white)



ACULON T11 8-24x25 <Black>



ACULON T11 8-24x25 <Blue>



ACULON T11 8-24x25 <Red>



ACULON T11 8-24x25 <White>

**ACULON A211** 7x35/8x42/10x42/7x50/10x50/12x50/16x50/8-18x42/10-22x50



**Durability and a large objective lens for the great outdoors**

- Aspherical eyepiece lens eliminates image distortion even at the lens periphery (except zoom models)
- Multilayer-coated lenses for bright images
- Turn-and-slide rubber eyecups facilitate easy positioning of eyes at the correct eyepoint (except zoom models)
- Rubber armour for shock-resistance and a firm, comfortable grip
- Smooth zooming with finger-tip zoom control (zoom models only)
- Can be fixed to a tripod using optional tripod adaptor (see p 54) (Tripod adaptor TRA-2 is a supplied accessory for the ACULON A211 16x50 and 10-22x50)



ACULON A211 8x42



ACULON A211 10-22x50

**ACULON A30** 8x25/10x25



**Strong performance in a compact body for added user confidence**

- Compact and lightweight
- Multilayer-coated lenses for bright images
- Long eye relief design ensures a clear field of view, even for eyeglass wearers (8x25)
- Firm, comfortable, rubber-coated grip
- Fold-up design; easy to carry around
- Eco-glass optics that are free of lead and arsenic are used for all lenses and prisms
- Available in two body colours: black and silver



ACULON A30 8x25 <Black>



ACULON A30 10x25 <Silver>



# High Grade

## When only superior performance will do

Among Nikon's broad lineup of widely acclaimed binoculars, the six HG L series models are designed for exceptional performance and comfort. Exacting lens and prism construction ensures sharper, brighter images to intensify your viewing experience. Other aspects, such as the finely tuned mechanics and optical design, work together to reveal subtle details you'd have otherwise missed.

### For bright, high-contrast images

- **Nikon's original multilayer coating**  
Minimises flare and ghosts, for very high transmission across a wide range of wavelengths. The result: excellent contrast and colour reproduction.
- **Phase correction coating**  
Corrects phase shifts caused when light reflects off the roof (Dach) prism. Provides a high-contrast image by eliminating the reduction of resolution.
- **High-reflection silver coating**  
Much greater reflectivity and much less light loss from the prism, compared with ordinary aluminium coating, for brighter images.

### For sharp, undistorted images

- **Field-flattener lens**  
Employed for eyepiece lens. Provides images that are sharp and clear all the way to the lens periphery.
- **Distortion correction**  
Nikon's outstanding optical design provides high-level distortion correction enabling sharp, undistorted images even at the viewing area periphery.

### Easy to use

- **Long eye relief design**  
Sophisticated design technology achieves a combination of long eye relief and small size.

- Soft-touch silicon rubber eyecup
- Turn-and-slide rubber eyecups with multi-click\* facilitate easy positioning of eyes at the correct eyepoint
- Large focusing ring makes for easier operation
- Every model is waterproof up to 2m/6.6 ft. (3m/9.8 ft. for 8x20HG L DCF/10x25HG L DCF) for 5 minutes and fog-free, with O-ring seals and nitrogen gas

- Made with environment-friendly materials  
Non-PVC (polyvinyl chloride) materials are used for the body, eyepiece lens cap, objective lens caps, case and wide strap; Eco-glass optics free of lead and arsenic are used for all lenses and prisms
- Can be fixed to a tripod using optional tripod adaptor\* (see p 54)

\*Except 8x20HG L DCF/10x25HG L DCF.



### Light transmission rates

Generally speaking, the higher the light transmission rate of a lens, the brighter and clearer your image will be, with less blur and ghosts. Each of Nikon's high-grade binocular models features a high light transmission rate thanks to our multilayer-coated lenses and prisms.

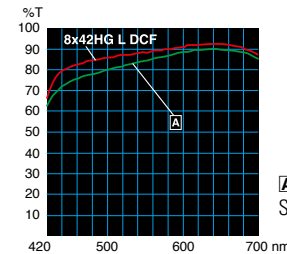

▲ Nikon conventional product  
Source: Nikon (actual value)



8x42HG L DCF



8x32HG L DCF



8x20HG L DCF



10x25HG L DCF

### 8x42HG L DCF/10x42HG L DCF



#### Supreme optical performance

- Lightweight (8x: 795g, 10x: 790g)
- Sturdy, lightweight die-cast magnesium alloy body
- Close focusing distance: 3m
- Dioptre adjustment ring locking system prevents unintentional rotation
- Excellent performance at temperatures as low as -20°C
- Rubber armouring for shock resistance and a firm, comfortable grip
- Ergonomic design for greater ease of holding
- Eyepiece lens caps are connected for easy use

### 8x32HG L DCF/10x32HG L DCF



#### Advanced optical performance in a smaller size

- Finely balanced compensation of aberrations
- Close focusing distance: 2.5m
- Dioptre adjustment ring locking system prevents unintentional rotation
- Excellent performance at temperatures as low as -20°C
- Rubber armouring for shock resistance and a firm, comfortable grip
- Ergonomic design for greater ease of holding
- Eyepiece lens caps are connected for easy use

### 8x20HG L DCF/10x25HG L DCF



#### Exceptional, compact performance

- Sturdy, lightweight die-cast magnesium alloy body
- Foldable design is convenient for carrying
- Close focusing distance: 2.4m (8x) and 3.2m (10x)
- Dioptre adjustment ring is located in the centre of the body, which improves operability
- Excellent performance at temperatures as low as -30°C



# Elegant Compact

## Up-close at concerts, the theatre and museums

Their compact size and stylish, sophisticated design mean that these models will perfectly complement those formal occasions when you need to look your best, whether at the theatre or concert performances. The short close-focusing distance makes these binoculars a natural for use in museums, too.



4x10DCF <Silver>

### 4x10DCF



#### Effortless performance in a sleek design

- Ultra-compact and lightweight (65g only)
- Close focusing distance: 1.2m
- All lenses and prisms are multilayer-coated for bright images
- Easy operation (Dioptre adjustment not required)
- Stylish design
- Available in three colours: black, silver and red



4x10DCF <Black>



4x10DCF <Red>

### 6x15M CF/7x15M CF Black



#### Timeless performance and design

- Stylish metal body
- Ultra-compact and lightweight
- Close focusing distance: 2m
- Multilayer-coated lenses for bright images



6x15M CF

### 5x15 HG Monocular/7x15 HG Monocular



#### Perfect for viewing masterpieces in sharp detail

- Prism features high-reflection silver coating for brighter images
- Phase-correction-coated prisms for high resolution
- Multilayer-coated lenses for bright images
- Long eye relief design ensures a clear field of view, even for eyeglass wearers (5x)
- Close focusing distance: 0.6m (5x), 0.8m (7x)



7x15 HG Monocular

# Compact

## Strong performance in sleek designs

When you're on the go, convenience is everything. That's what makes Nikon's compact lineup so appealing — small enough to take anywhere, they're ideal for your next holiday, or at a concert or sporting event.



Sportstar EX 8x25DCF <Charcoal grey>

### Sportstar EX 8x25DCF/10x25DCF



#### Power to pull in the details, small enough for your pocket

- Waterproof and fog-free with nitrogen gas
- Turn-and-slide rubber eyecups facilitate easy positioning of eyes at the correct eyepoint
- Close focusing distance: 2.5m (8x), 3.5m (10x)
- Multilayer-coated lenses for bright images
- Compact and lightweight
- Fold-up design; easy to carry around
- Available in two body colours (silver/charcoal grey)



Sportstar EX 8x25DCF <Silver>

### TRAVELITE EX 8x25CF/9x25CF/10x25CF/12x25CF



#### Lightweight compact for more versatile use

- Waterproof (up to 2m/6.6 ft. for 5 minutes) and fog-free with nitrogen gas
- Aspherical eyepiece lens eliminates image distortion
- Long eye relief design ensures a clear field of view, even for eyeglass wearers
- Close focusing distance: 2.8m
- Multilayer-coated lenses for bright images
- Turn-and-slide rubber eyecups facilitate easy positioning of eyes at the correct eyepoint
- Eco-glass optics are free of lead and arsenic



TRAVELITE EX 8x25CF

### TRAVELITE VI 8x25CF/10x25CF/12x25CF



#### All-round use, smooth operation

- Redesigned body enhances ergonomics
- Aspherical lenses minimise distortion and provide sharp images up to the periphery
- Multilayer-coated lenses for bright images
- Special rubber armour for shock-resistance and a firm, comfortable grip
- Carbon fibre in the body material improves durability
- Compact and lightweight
- Click-type dioptre adjustment ring prevents unintentional rotation
- Larger focusing knob for smooth operation
- Eco-glass optics are free of lead and arsenic



TRAVELITE VI 8x25CF

\* For specifications, see p 52.

\* For specifications, see pp 52-53.



# Marine

## Nikon professional for smoother sailing

For top performance in a marine environment, Nikon binoculars are the way to go. All of the models in our Marine lineup deliver crisp, brilliant images. They're filled with nitrogen gas and sealed with O-rings to minimise the effect of temperature changes, making them ideal for rugged nautical applications. And select models even feature a built-in compass to keep you on course. Waterproof, weather-resistant binoculars you can count on.



7x50IF HP WP Tropical

### 7x50CF WP/7x50CF WP Compass



#### Easy focus on water or land

- Central focusing system; waterproof (up to 1m/3.3 ft. for 5 minutes) and fog-free with O-ring seals and nitrogen gas
- Built-in compass with illuminator and scale (7x50CF WP Compass)
- Long eye relief design ensures a clear field of view, even for eyeglass wearers
- Multilayer-coated lenses for bright images
- Rubber armouring for shock resistance and a firm, comfortable grip
- Floating strap provided
- Can be fixed to a tripod using optional tripod adaptor (see p 54)



Floating strap for 7x50CF WP/7x50CF WP Compass



7x50CF WP Compass

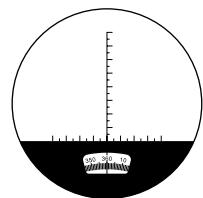

**Compass and distance scale (for 7x50CF WP Compass)**  
You can measure dimensions or distances if you know one of the values.



7x50IF WP Compass

### 7x50IF WP/7x50IF WP Compass



#### Specially designed for maritime professionals

- Waterproof (up to 2m/6.6 ft. for 5 minutes) and fog-free with nitrogen gas
- All lenses and prisms are multilayer-coated for bright images
- Rubber armouring for shock resistance and a firm, comfortable grip
- Long eye relief design ensures a clear field of view, even for eyeglass wearers
- Built-in compass and scale to ascertain subject direction, and distance or size (7x50IF WP Compass)
- Can be fixed to a tripod using optional tripod adaptor (see p 54)



#### Optional accessories

##### Polarising filter (option)

This filters out light reflections from water or glass.

##### Horn-shaped rubber eyecup (option)

Keeps light out of the eyepiece for easy viewing. Comfortable rubber cups are soft on your face, particularly good for use on bright days at sea and in other extreme conditions.

##### Usable models

- 7x50IF HP WP Tropical
- 18x70IF WP WF
- 7x50IF SP WP
- 10x70IF SP WP
- 10x70IF HP WP

### 7x50IF HP WP Tropical (Model with built-in scale available)



#### Trusted standard for fisheries and professional marine navigation

- Waterproof (up to 5m/16.4 ft. for 5 minutes) and fog-free with nitrogen gas
- Horizontal and vertical scales for measuring dimensions or distances (scale type)
- Long eye relief design ensures a clear field of view, even for eyeglass wearers
- Large objective diameter for bright image
- Can be fixed to a tripod using optional tripod adaptor (see p 54)
- Polarising filter and horn-shaped rubber eyecup are available (options)

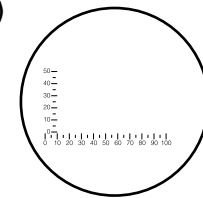

**Distance scale**  
You can measure dimensions or distances if you know one of the values.



7x50IF HP WP Tropical

### 10x70IF HP WP



#### Extra magnification for maritime professionals

- Waterproof (up to 2m/6.6 ft. for 5 minutes) and fog-free with nitrogen gas
- Large 70mm objective diameter meets demand for exceptionally bright, high magnification
- Long eye relief design ensures a clear field of view, even for eyeglass wearers
- Can be fixed to a tripod using optional tripod adaptor (see p 54)
- Polarising filter and horn-shaped rubber eyecup are available (options)



10x70IF HP WP

### 10x50CF WP



#### Waterproof durability, even in harsh conditions

- Waterproof (up to 1m/3.3 ft. for 5 minutes) and fog-free with nitrogen gas
- Multilayer-coated large 50mm objective lens for bright images
- Long eye relief design ensures a clear field of view, even for eyeglass wearers
- Rubber armouring for shock resistance and a firm, comfortable grip
- Wide strap
- Can be fixed to a tripod using optional tripod adaptor (see p 54)



10x50CF WP

# Standard

## Action EX 7x35CF/8x40CF/7x50CF/10x50CF/12x50CF/16x50CF



#### A broader field of view in the most challenging conditions

- Waterproof (up to 1m/3.3 ft. for 5 minutes) and fog-free with nitrogen gas
- Long eye relief design ensures a clear field of view, even for eyeglass wearers
- Turn-and-slide rubber eyecups with multi-click
- Multilayer-coated lenses and large objective diameter for optimal image clarity
- Rubber armouring for shock resistance and a firm, comfortable grip
- Eco-glass optics are free of lead and arsenic
- Aspherical eyepiece lens eliminates image distortion (7x50CF, 12x50CF only)
- Wide strap
- Can be fixed to a tripod using optional tripod adaptor (16x50CF includes tripod adaptor) (see p 54)



Action EX 8x40CF

# The Standard for Advanced Nature Observation

## Studying nature at its finest

High-performance binoculars widely acknowledged as the standard for specialised activities such as birdwatching and nature observation, providing optical clarity and sharpness. And in models designed for stargazing, you'll enjoy sharp, edge-to-edge resolution that exceeds your expectations.

### 8x30E II/10x35E II



**The birdwatching standard, offering pristine panoramic views and easy locating of subjects**

- Optics employ Eco-glass containing no arsenic or lead
- Wide apparent field of view (63.2° for 8x30E II, 62.9° for 10x35E II)
- Close focusing distance: 3m (8x), 5m (10x)
- Lightweight, die-cast magnesium-alloy body
- All lenses and prisms are multilayer-coated for bright images
- Can be fixed to a tripod using optional tripod adaptor (see p 54)



8x30E II

### 7x50IF SP WP/10x70IF SP WP



**Edge-to-edge sharpness for seafarers, stargazing**

- Superior optical design for aberration-free observation, built especially for astronomical use
- Multilayer-coated lenses for bright images
- Waterproof up to 5m/16.4 ft. (2m/6.6 ft. for 10x70IF SP WP) for 5 minutes and fog-free with O-ring seals and nitrogen gas
- Long eye relief design ensures a clear field of view, even for eyeglass wearers
- Can be fixed to a tripod using optional tripod adaptor (see p 54)
- Polarising filter and horn-shaped rubber eyecup are available (options, see p 24)

7x50IF SP WP



### 18x70IF WP WF



**Extra magnification for seafarers, stargazing**

- Wide 64.3° apparent angular field of view
- All lenses are multilayer-coated for bright images
- Waterproof (up to 2m/6.6 ft. for 5 minutes) and fog-free with O-ring seals and nitrogen gas
- Long eye relief design ensures a clear field of view, even for eyeglass wearers
- Can be fixed to a tripod using optional tripod adaptor (see p 54)
- Polarising filter and horn-shaped rubber eyecup are available (options, see p 24)

18x70IF WP WF



\* For specifications, see p54.

# StabilEyes

## All StabilEyes models offer

- Reduced vibration for superior performance and steady view
- Fully multilayer-coated lenses for optimal brightness
- Phase-correction-coated prisms for high resolution
- Waterproof and fog-free with O-ring seals and nitrogen gas
- Ergonomic styling for comfortable grip, easy access to controls



Without vibration reduction



With vibration reduction

StabilEyes 12x32



StabilEyes 16x32



### StabilEyes 14x40



- Two vibration reduction modes: LAND mode for when footing is secure, to compensate for vibration from hand-shake and binocular movement when user follows a moving subject while studying nature or watching sports. ON BOARD mode for when footing is unstable due to strong vibration — for example, from an engine or strong wind
- Floating strap provided

StabilEyes 14x40



## StabilEyes 12x32/16x32



- Nikon's exclusive VR PAUSE button maintains a comfortable view while panning, tilting or following fast-moving objects
- Long eye relief design allows use with eyeglasses
- Turn-and-slide rubber eyecups
- Soft-to-the-touch neck strap included

Model name	StabilEyes 14x40	StabilEyes 12x32	StabilEyes 16x32
Magnification (x)	14	12	16
Vibration reduction system	Optical compensation by erecting prisms with gimballed frame		
Vibration compensation range (°)	±5	±3	
Objective diameter (mm)	40	32	
Eye relief (mm)	13	15	
Dioptre adjustment (dpt.)	±2	±3	
Field of view (real) (°)	4	5	3.8
Field of view (apparent) (°)	52.1	55.3	55.9
Field of view at 1,000m (m)	70	87	66
Exit pupil (mm)	2.9	2.7	2.0
Relative brightness	8.4	7.3	4.0
Interpupillary distance adjustment (mm)	60-70	56-72	
Close focusing distance (m)	5	3.5	
Dimensions (L x W x D) (mm)	186 x 148 x 88	178 x 142 x 81	181 x 142 x 81
Weight (without batteries) (g)	1,340	1,130	1,120
Operating temperature range (°C)	-10 to +50		
Battery	DC 6V (four AA-type alkaline batteries)	DC 3V (two AA-type alkaline batteries)	
Battery life	Approx. 6 hours*		

\*Continuous operation with AA-type alkaline batteries at normal temperature (20°C).

Note: Apparent field of view is calculated based on the ISO 14132-1:2002 standard. For details, see p 54.





# Fieldsopes

## A whole wide world of discovery

Nikon offers a broad selection of the finest Fieldsopes and interchangeable eyepieces, all delivering peerless magnification through brilliant optics while featuring rugged construction. What's more, by attaching Nikon digital cameras to our Fieldsopes, you can capture and enjoy great close-up photos without having to carry along heavy telephoto lenses.







## Nikon EDG Fieldsopes deliver a spectacular field of view

In the pursuit of innovation, Nikon's cutting-edge technology has enabled the incorporation of a lens-shift type VR (Vibration Reduction) system into fieldsopes for the first time in the world\* — EDG VR Fieldsopes. Sophisticated optical technologies complement superb mechanical functions in EDG Fieldsopes, all were created to attain clear-cut superiority for both observation and digiscoping applications. Following a comprehensive series of CAE (Computer Aided Engineering) simulations and data analyses, our EDG design engineers built numerous prototypes. These efforts realised a tough, finely balanced structure; a large-diameter objective lens that delivers brighter images; a large focusing ring for smooth operation even during digiscoping; and a tripod mount that features finely tuned weight balance adjustments. The result is exquisite, clear viewing to the very edge of your field of view.

\*As of October, 2011.



EDG Fieldscope 85 VR

EDG Fieldscope 85-A VR



EDG Fieldscope 85-A VR



EDG Fieldscope 85 VR



EDG Fieldscope 65-A



EDG Fieldscope 65

### EDG Fieldscope 85 VR/85-A VR EDG Fieldscope 85/85-A/65/65-A



#### Experience comfortable viewing with Nikon's premium EDG brand Fieldsopes

(EDG VR Fieldsopes only)

- The world's first Fieldsopes featuring Nikon's lens-shift type VR (Vibration Reduction) system (as of October, 2011)
- Reduces vibrations to approx. 1/8\*1 during observation, providing the equivalent of a shutter speed approx. 2 stops\*1 faster in digiscoping
- Easy VR operation; after turning the VR lock knob, pressing the VR button once activates the function
- VR function turns off automatically after approx. 30 minutes of turning VR on (Auto power off function)
- Readily available AA-size batteries are used

(Common features)

- Extra-low dispersion (ED) glass for chromatic aberration compensation and brighter, clearer viewing
- Dielectric high-reflective multilayer prism coating on roof prism unit for the brightest view (straight models only)
- Phase-correction-coated roof prism for high resolution
- Advanced multilayer coating is applied to all lenses and prisms for the brightest images
- Waterproof (up to 2m/6.6 ft. for 10 minutes)\*2 and fog-free with nitrogen gas (the body/eyepiece joint and the body/battery holder joint are water-resistant\*3)
- Stylish design
- Three tripod mount screw holes provided for flexible mounting; optimum balance achieved through CAE (Computer Aided Engineering)
- Seven eyepieces exclusively for EDG Fieldsopes are optionally available
- Built-in sliding hood blocks harmful light and protects objective lens

\*1 Based on Nikon Fieldscope measuring standard (used with tripod).

\*2 NOT designed for underwater usage.

\*3 Water resistance: As tested by water equivalent to 1mm per minute, falling from a height of more than 200mm for a duration of 10 minutes (in normal use with an eyepiece attached to the main body correctly).

#### Eyepieces for EDG Fieldsopes

- Seven kinds of eyepieces for optimum optical performance
- Bayonet mount with lock for easy attachment and release
- Fully multilayer-coated
- Waterproof up to 2m for 10 min., and fog-free — thanks to O-rings and nitrogen gas (body-and-eyepiece joint is water-resistant)
- Turn-and-slide eyecup with three click stops: one for observing with the naked eye, one for observing with eyeglasses, and the other for digiscoping (except FEP-30W, FEP-25 LER and FEP-20-60)
- FEP-30W offers a choice of eyecup: soft rubber eyecup for

observation and digiscoping eyecup for connection with digital cameras using optional digiscoping accessories

- FEP-25 LER has ultra-long 32.3mm eye relief
- FEP-20-60 featuring long eye relief of 18.4-16.5mm employs a moulded glass aspherical lens to minimise image distortion
- Compact Digital Camera COOLPIX series and Advanced Camera with Interchangeable Lenses Nikon 1 series can be attached using optional digiscoping accessories (except FEP-20-60)

\* For more information about digiscoping accessories or compatible cameras, see [www.nikon.com/sportoptics/](http://www.nikon.com/sportoptics/)





# PROSTAFF 5

## PROSTAFF 5 Fieldscope 82/82-A/60/60-A



### Brighter viewing in a sleek design

- Compact, lightweight and smooth ergonomic design
- Large objective lens for a brighter field of view
- All lenses and prisms are multilayer-coated for bright images
- Chromatic aberration at the peripheries of the viewfield is minimised
- Waterproof (up to 1m/3.3 ft. for 10 minutes) and fog-free with nitrogen gas (Eyepieces are water-resistant when attached to the Fieldscope body)
- Bayonet-type eyepiece mount with locking system enables quicker, more secure eyepiece connections
- Three eyepieces exclusively for PROSTAFF 5 Fieldscopes are optionally available: compatible with digital camera bracket FSB-series
- Built-in sliding hood



PROSTAFF 5 Fieldscope 82



PROSTAFF 5 Fieldscope 82-A



PROSTAFF 5 Fieldscope 60



PROSTAFF 5 Fieldscope 60-A

### Eyepieces for PROSTAFF 5 Fieldscopes

- Fully multilayer-coated
- Long eye relief design for viewing comfort with eyeglasses
- Usable for both observation and digiscoping
- Bayonet mount with lock for easy attachment and release
- Water-resistant when attached to Fieldscope body



# PROSTAFF 3

## PROSTAFF 3 Fieldscope



### Compact design and reliable performance

- Compact, lightweight and sleek design
- All lenses and prisms are multilayer-coated for bright images
- 16-48x zoom eyepiece integrated
- Long eye relief (19mm at 16x)
- Rubber armoring
- Waterproof (up to 1m/3.3 ft. for 10 minutes) and fog-free with nitrogen gas
- Comes with a compact tripod and a carrying case



PROSTAFF 3 Fieldscope



PROSTAFF 3 Fieldscope with supplied tripod and carrying case

# ED50/ED50 A

## Fieldscope ED50/ED50 A



### Nikon's smallest high-end scope features brilliant optics

- Compact and lightweight with 50mm-diameter ED (Extra-low Dispersion) objective lens to minimise chromatic aberration
- Available in straight or angled design
- Multilayer-coated lenses for bright images
- Waterproof (up to 1m/3.3 ft. for 5 minutes) and fog-free with nitrogen gas
- Choose from two colours — charcoal grey and pearlescent green
- Compatible with MC eyepieces and Wide DS eyepieces (options)
- 55mm filter (P=0.75) can be attached to objective lens



Fieldscope ED50 A (Charcoal grey)



Fieldscope ED50 (Pearlescent green)



Hand-holding case for Fieldscope ED50 series (option)

### Eyepieces for Fieldscopes



These eyepieces can be used with EDG Fieldscopes via FS Eyepiece Mount Adaptor EMA-1.

# Nikon Digiscoping System

This convenient system makes it possible to record images viewed through a Fieldscope. Connecting a Fieldscope using an attachment or bracket for a Nikon digital SLR camera, an Advanced Camera with Interchangeable Lenses Nikon 1 series or a Nikon COOLPIX series camera, makes it easy for the user to capture super-telephoto images. Now, thanks to the unrivalled combination of Nikon cameras and Nikon scopes, you'll achieve striking images in a way that no other system can offer.

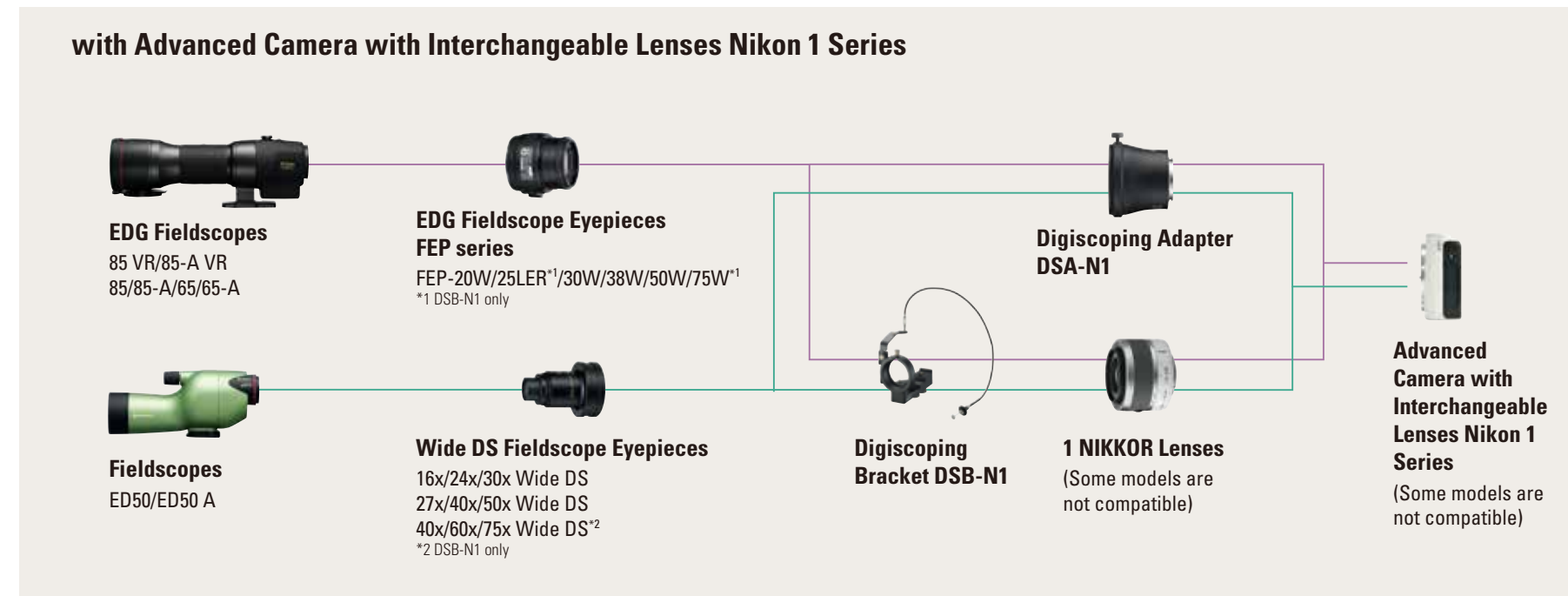

• Vignetting may occur even with compatible models, depending on the subject and other shooting conditions.  
• For more information and details of compatible models, see [www.nikon.com/sportoptics](http://www.nikon.com/sportoptics)  
• The above charts are as of July 2014.

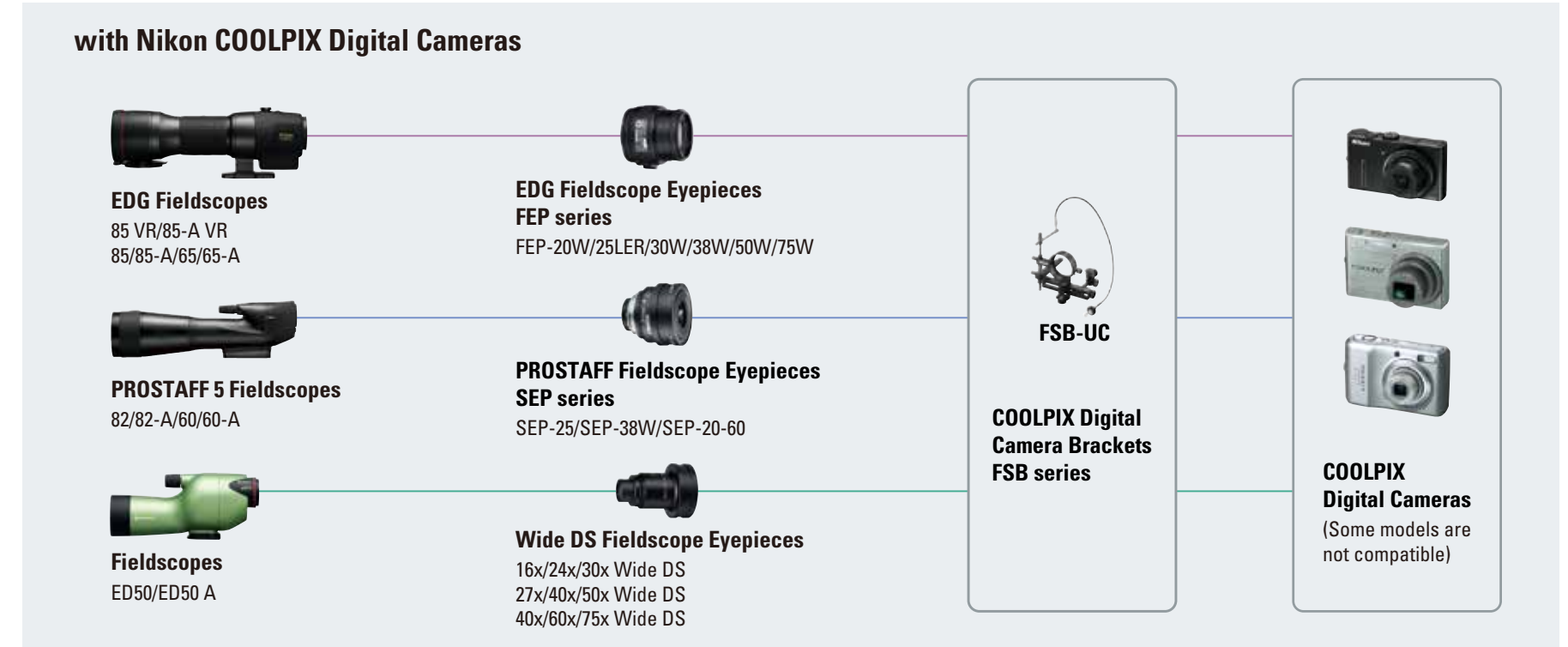

• Vignetting may occur even with compatible models, depending on the subject and other shooting conditions.  
• For more information and details of compatible models, see [www.nikon.com/sportoptics](http://www.nikon.com/sportoptics)  
• The above chart is as of July 2014.

**Fieldscope Digital SLR Camera Attachment FSA-L2**  
(exclusively for EDG Fieldscope)

- 3.5x zoom for super telephoto shooting. When attached to EDG Fieldscope 85 VR/85-A VR/85/85-A, the focal length ranges from 500 to 1,750mm\* and when attached to EDG Fieldscope 65/65-A, the focal length ranges from 400 to 1,400mm\*. \*FX format
- Available exposure modes: Aperture-Priority Auto and Metered Manual  
Available exposure metering: Centre-weighted metering
- Multilayer coating is applied to all lens elements for brighter optics

**Digiscoping Adapter DSA-N1**  
(exclusively for Nikon 1 series)

- Attaches to a Nikon Fieldscope easily, since optical axis adjustment is not required
- Allows use of the camera's A: Aperture-priority auto and M: Manual exposure modes
- Easy-to-carry compact size

**Digital Camera Bracket FSB-UC**  
(universal type for COOLPIX series)

- The new design allows the replacement of batteries and recording media while the camera is attached to a Fieldscope, or Fieldmicroscope (this is not possible with some COOLPIX models)
- Includes a light shielding rubber sheet that minimises harmful, incoming rays and glare
- Includes cable release (approx. 50cm) to prevent camera shake during shooting

**Digiscoping Bracket DSB-N1**  
(exclusively for Nikon 1 series)

- Includes a cable release (approx. 50cm) to prevent camera shake when shooting; the cable release socket is attached to the bracket
- Includes a light-shielding rubber sheet to prevent external light from entering



# Laser Rangefinders

## The measure of excellence

Acclaimed throughout the world for superior optical technologies and leading-edge design, Nikon takes pride in delivering innovative products of the very highest quality. Nikon's Laser Rangefinder lineup features a variety of models to choose from, each instrument perfectly suited to its particular purpose.



# COOLSHOT AS

### ID Technology displays slope adjusted distance to improve your golf score

- Measurement range: 4.5-550m/5-600 yds.
- Easy operation enables measurement of actual distance, horizontal distances, height and slope adjusted distance (horizontal distance ± height)
- Golf mode displays the slope adjusted distance (Horizontal distance ± Height) which is a guide for how far you should hit the ball and useful when golfing on an uphill/downhill course — ID (incline/decline) Technology
- Target Priority Switch System for measuring overlapping subjects: First Target Priority mode displays the distance of the closest subject — useful when golfing for measuring the distance to a flagstick on a green with woods in the background. Distant Target Priority mode displays that of the farthest subject — useful in wooded areas.
- Compact, lightweight and ergonomic design enables easy, single-hand operation
- High-quality 6x monocular with multilayer coating for bright, clear images
- High light transmittance for a brighter field of view
- Large ocular for easy viewing (18mm)
- Wide field of view (7.5 degrees)
- Long eye relief design affords eyeglass wearers easy viewing
- Dioptre adjustment function
- Single or continuous measurement (up to 8 seconds)
- LED illumination for easy viewing of the display in dark conditions
- Waterproof (up to 1m for 10 minutes), but not for underwater usage; the battery chamber is water-resistant
- Wide temperature tolerance: -10°C to +50°C



COOLSHOT AS



### Internal display

1. Distance
2. Unit of measure (m/yd.)
3. Target mark (—|—)
4. Laser irradiation (X)
5. Height (Actual distance at Golf mode setting)
6. Battery condition
7. Distant Target Priority mode
8. First Target Priority mode
9. Decline
10. Incline

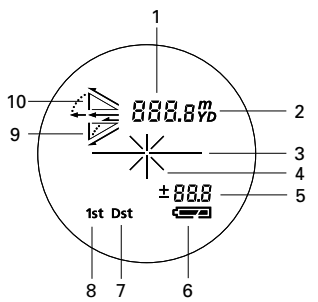

### Display mode cycle

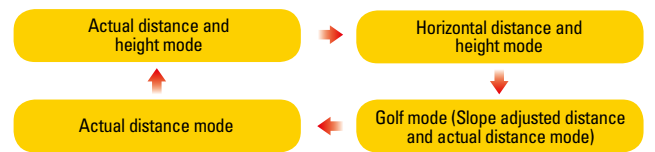

### Golf mode

Provides the "Horizontal distance ± Height" speedily enabling you to confidently determine how to approach the course. Once your sense of distance is enhanced, you can more easily achieve the correct shot.

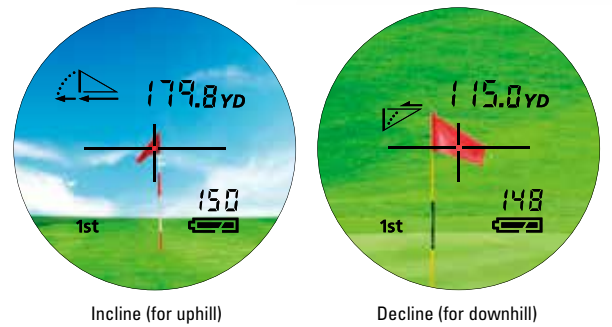

Incline (for uphill)

Decline (for downhill)

The upper figure shows the "slope adjusted distance" and the lower figure is the "actual distance". Both are displayed simultaneously in the internal display.

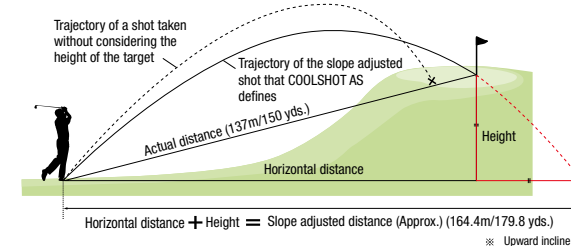

\* For specifications, see p 58.



# COOLSHOT

## Enjoy golfing with one-push continuous measurement and First Target Priority mode

- Measurement range: 10-550m/11-600 yds.
- First Target Priority mode is employed.  
When measuring overlapping subjects, the distance of the closest subject is displayed — useful when golfing for measuring the distance to a flagstick on a green with woods in the background.
- A single press of the POWER button provides 8-second continuous measurement, which enables measurement even with slight hand movement
- Compact, lightweight and ergonomic design
- Distance measurement display step is 0.5m/yd.
- High-quality 6x monocular with multilayer coating for bright, clear images
- High light transmittance for a brighter field of view
- Large ocular for easy viewing (18mm)
- Wide field of view (7.5 degrees)
- Long eye relief design affords eyeglass wearers easy viewing
- Dioptre adjustment function
- LED illumination for easy viewing of the display in dark conditions
- Waterproof (up to 1m/3.3 ft. for 10 minutes), but not for underwater usage; the battery chamber is water-resistant
- Wide temperature tolerance: -10°C to +50°C

### Internal display

1. Distance
2. Unit of measure (m/yd.)
3. Target mark (—|—)
4. Laser irradiation (×)
5. Battery condition

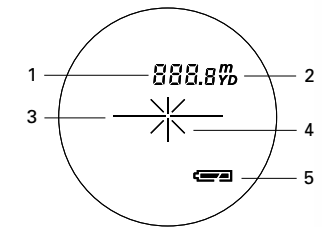

COOLSHOT



# COOLSHOT 20

## Compact laser rangefinder employing First Target Priority mode with one-push continuous measurement

- Measurement range: 5-500m/6-550 yds.
- First Target Priority mode is employed.  
When measuring overlapping subjects, the distance of the closest subject is displayed — useful when golfing for measuring the distance to a flagstick on a green with woods in the background.
- A single press of the POWER button provides 8-second continuous measurement, which enables measurement even with slight hand movement
- Compact, lightweight (approx. 125g) and ergonomic design
- Distance measurement display step is 1m/yd.
- High-quality 6x monocular with multilayer coating for bright, clear images
- Long eye relief design affords eyeglass wearers easy viewing
- Dioptre adjustment function
- Rainproof — JIS/IEC protection class 4 (IPX4) equivalent (under our testing conditions)
- Wide temperature tolerance: -10°C to +50°C

### Internal display

1. Distance
2. Unit of measure (m/yd.)
3. Target mark (—|—)
4. Laser irradiation (×)
5. Battery condition

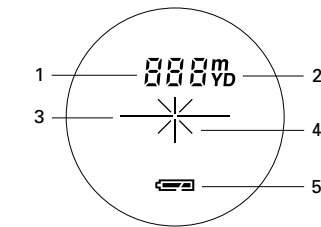

COOLSHOT 20



\* For specifications, see p 58.





# PROSTAFF

**Ideal for wooded areas — ID Technology displays horizontal distance and actual distance**

- Measurement range: 4.5-550m/5-600 yds.
- Horizontal Distance display mode and Actual Distance display mode can be easily switched — ID (incline/decline) Technology
- Target Priority Switch System for measuring overlapping subjects: First Target Priority mode displays the distance of the closest subject — useful when measuring the distance to a subject in front of an overlapping background. Distant Target Priority mode displays that of the farthest subject — useful in wooded areas.
- Compact, lightweight and ergonomic design
- Distance measurement display step is 0.1m/yd.
- High-quality 6x monocular with multilayer coating for bright, clear images
- High light transmittance for a brighter field of view
- Large ocular for easy viewing (18mm)
- Wide field of view (7.5 degrees)
- Long eye relief design affords eyeglass wearers easy viewing
- Dioptre adjustment function
- Single or continuous measurement (up to 8 seconds)
- LED illumination for easy viewing of the display in dark conditions
- Waterproof (up to 1m/3.3 ft. for 10 minutes), but not for underwater usage; the battery chamber is water-resistant
- Wide temperature tolerance: -10°C to +50°C



PROSTAFF 7



**Internal display**

1. Distance
2. Unit of measure (m/yd.)
3. Target mark (—|—)
4. Laser irradiation (X)
5. Battery condition
6. Horizontal Distance display mode
7. First Target Priority mode
8. Distant Target Priority mode

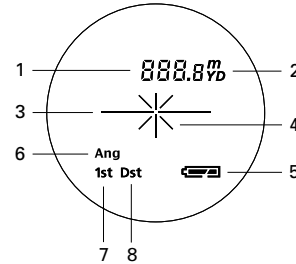

**Display mode cycle**



# PROSTAFF

**Easy-to-hold, ergonomically designed body plus ID Technology**

- Measurement range: 7.3-590m/8-650 yds.
- Horizontal Distance display mode and Actual Distance display mode can be easily switched — ID (incline/decline) Technology
- Target Priority Switch System for measuring overlapping subjects: First Target Priority mode displays the distance of the closest subject — useful when measuring the distance to a subject in front of an overlapping background. Distant Target Priority mode displays that of the farthest subject — useful in wooded areas.
- Compact, lightweight and ergonomic design
- Distance measurement display step is 0.1m/yd.
- High-quality 6x monocular with multilayer coating for bright, clear images
- Large ocular for easy viewing (18mm)
- Wide field of view (7.5 degrees)
- Long eye relief design affords eyeglass wearers easy viewing
- Dioptre adjustment function
- Single or continuous measurement (up to 8 seconds)
- Rainproof — JIS/IEC protection class 4 (IPX4) equivalent (under our testing conditions)
- Wide temperature tolerance: -10°C to +50°C



PROSTAFF 3i



**Internal display**

1. Distance
2. Unit of measure (m/yd.)
3. Target mark (—|—)
4. Laser irradiation (X)
5. Battery condition
6. Horizontal Distance display mode
7. First Target Priority mode
8. Distant Target Priority mode

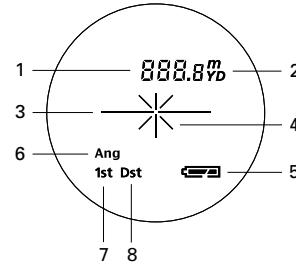

**Display mode cycle**



# ACULON

**Compact laser rangefinder with Distant Target Priority mode**

- Measurement range: 5-500m/6-550 yds.
- Distant Target Priority mode is employed. When measuring overlapping subjects, the distance of the farthest subject is displayed — useful in wooded areas.
- Compact, lightweight (approx. 125g) and ergonomic design
- Distance measurement display step is 1m/yd.
- High-quality 6x monocular with multilayer coating for bright, clear images
- Long eye relief design affords eyeglass wearers easy viewing
- Dioptre adjustment function
- Single or continuous measurement (up to 20 seconds)
- Rainproof — JIS/IEC protection class 4 (IPX4) equivalent (under our testing conditions)
- Wide temperature tolerance: -10°C to +50°C

**Internal display**

1. Distance
2. Unit of measure (m/yd.)
3. Target mark (—|—)
4. Laser irradiation (X)
5. Battery condition

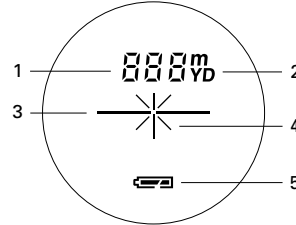

ACULON



# Laser 1000A S

## Features a long measurement range, golf mode and inclinometer, for a variety of purposes

- Measurement range: 10-915m/11-1,000 yds.
- Active Brightness Control Viewfinder for easy, clear viewing: Orange LED is automatically turned on when it is used in darker situations and brightness of the LED is adjusted according to the surroundings
- Easy operation enables measurement of actual distance, horizontal distance, height and slope adjusted distance (horizontal distance ± height)
- Target Priority Switch System for measuring overlapping subjects: First Target Priority mode displays the distance of the closest subject — useful when measuring the distance to a subject in front of an overlapping background. Distant Target Priority mode displays that of the farthest subject — useful in wooded areas.
- High-quality 6x monocular with multilayer coating for bright, clear images
- High light transmittance for a brighter field of view
- Large ocular for easy viewing (18mm)
- Wide field of view (7.5 degrees)
- Long eye relief design affords eyeglass wearers easy viewing
- Dioptre adjustment function
- Single or continuous measurement (up to 5 seconds)
- Compact, lightweight design enables easy, single-hand operation
- Waterproof (up to 1m/3.3 ft. for 10 minutes), but not for underwater usage; the battery chamber is water-resistant
- Wide temperature tolerance: -10°C to +50°C

## Golf mode

Provides the "Horizontal distance ± Height" speedily enabling you to confidently determine how to approach the course. Once your sense of distance is enhanced, you can more easily achieve the correct shot.

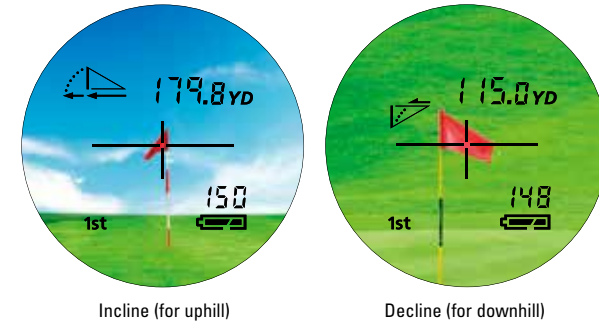

The upper figure shows the "slope adjusted distance" and the lower figure is the "actual distance". Both are displayed simultaneously in the internal display.

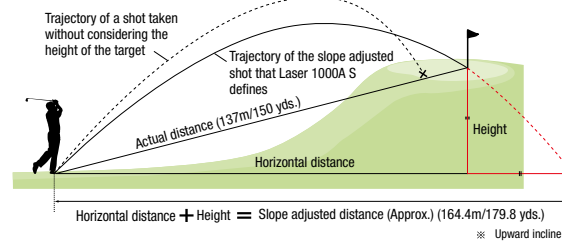

## Internal display

1. Distance
2. Unit of measure (m/yd.)
3. Target mark (—|—)
4. Laser irradiation (X)
5. Height (Actual distance at Golf mode setting)
6. Battery condition
7. Distant Target Priority mode
8. First Target Priority mode
9. Decline
10. Incline

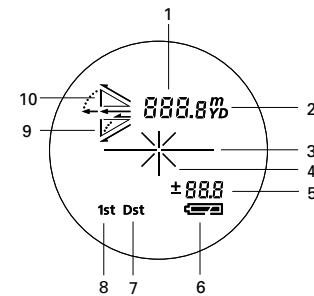

## Display mode cycle

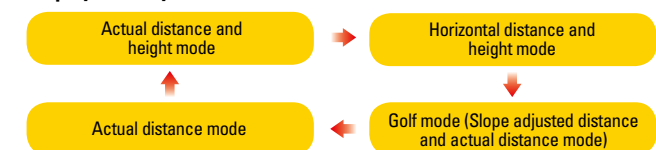

Laser 1000A S



# Laser 1200S

## Achieves long-distance measurement up to 1,100m (1,200 yds.)

- Measurement range: 10-1,100m/11-1,200 yds.
- Target Priority Switch System for measuring overlapping subjects: First Target Priority mode displays the distance of the closest subject — useful when measuring the distance to a subject in front of an overlapping background. Distant Target Priority mode displays that of the farthest subject — useful in wooded areas.
- High-quality 7x monocular with multilayer coating for bright, clear images
- Long eye relief design affords eyeglass wearers easy viewing
- Dioptre adjustment function
- Single or continuous measurement (up to 20 seconds)
- Easy one-push measurement after the power is turned on
- Compact, lightweight design enables easy, single-hand operation
- LCD with backlight
- Waterproof (up to 2m/6.6 ft. for 5 minutes), but not for underwater usage; the battery chamber is water-resistant
- Wide temperature tolerance: -10°C to +50°C

## Internal display

1. Distance
2. Unit of measure (m/yd.)
3. Target mark (—|—)
4. Laser irradiation (X)
5. First Target Priority mode
6. Battery condition

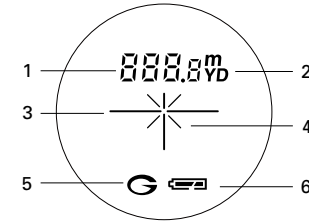

Laser 1200S



# Forestry Pro

## Ideal for basic forestry and land surveys — display in metres, yards or feet

- Measurement range: 10-500m/11-550 yds./33-999 ft.
- In addition to actual distance, horizontal distance, height, angle and vertical separation (difference in height between two targets) measurement functions, three-point measurement (height between two points) is available
- The results are displayed on both internal and external LCD panels. The external panel displays all results simultaneously.
- Target Priority Switch System for measuring overlapping subjects: First Target Priority mode displays the distance of the closest subject — useful when measuring the distance to a subject in front of an overlapping background. Distant Target Priority mode displays that of the farthest subject — useful in wooded areas.
- High-quality 6x monocular with multilayer coating produces bright, clear images
- Long eye relief design affords eyeglass wearers easy viewing
- Dioptre adjustment function
- Single or continuous measurement (up to 20 seconds)
- Waterproof (up to 1 meter for 10 minutes) but not for underwater usage; the battery chamber is water resistant
- Wide temperature tolerance: -10°C to +50°C

## Internal display

1. Actual Distance
2. Horizontal Distance
3. Height
4. Height between two points
5. Three-point measurement
6. Unit of measure (m/yd.) (No unit displayed for ft.)
7. Target mark (—|—)
8. Laser irradiation (X)
9. Battery condition
10. Distant Target Priority mode
11. First Target Priority mode
12. Angle
13. Distance

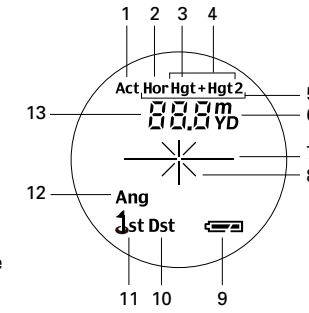

## External display

1. Measurement unit (m/yd./ft.)
2. Height
3. Actual Distance
4. Horizontal Distance
5. Angle (°)

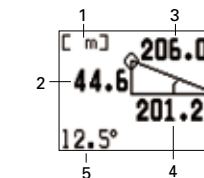

## Measurement example (Three-point measurement: height between two points)

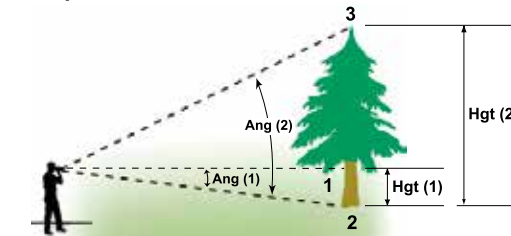

## Internal display

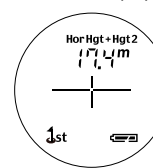

## External display

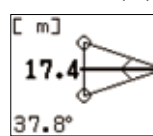

When three-point measurement is achieved, the height between points 2 and 3 is displayed on the internal LCD with Hor Hgt+Hgt2 (solid), and Hgt(2) and Ang(2) are shown on the external LCD. Points 2 and 3 can be reversed.

## Measurement example (2-point height measurement)



## Internal display

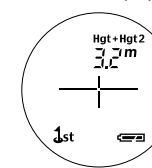

## External display

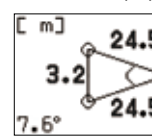

When the measurement is successful, you see the height from the base to the top displayed on the internal LCD with Hgt + Hgt2 (solid). For more information, refer to the external LCD. "Base" and "Top" can be switched.



Forestry Pro





# Exceptional Optics for Specialised Needs

Dedicated applications demand the expert attention that only Nikon delivers



## Binocular Telescope

### 20x120 III Binocular Telescope

- Large 120mm objective diameter and Nikon's original coating for bright images even in the dark
- Sharp image realised by aberration compensation
- Waterproof (up to 2m/6.6 ft. for 10 minutes), filled with nitrogen gas, fog-free and dust resistance
- Shock and corrosion-resistant structure
- Long eye relief design ensures a clear field of view, even for eyeglass wearers
- Easy handling with 360° azimuth and -30° — +70° tilting
- Height (with stand, binocular tubes in horizontal position): 440mm
- Rigid fixed-pillar stand (option) is available



20x120 III with pillar stand

Model name	20x120 III
Magnification (x)	20
Objective diameter (mm)	120
Angular field of view (Real) (°)	3.0
Angular field of view (Apparent) (°)	55.3
Field of view at 1,000m (m)	52
Exit pupil (mm)	6.0
Relative brightness	36.0
Eye relief (mm)	20.8
Close focusing distance (m)	133.0
Interpupillary distance adjustment (mm)	58-74
Weight (kg)	15.5*
Length (mm)	680*
Width (mm)	452*
Type	Porro

\* Binocular body only.

Note: Apparent field of view is calculated based on the ISO 14132-1:2002 standard. For details, see p 54.





# Loupes



## Reading Magnifier L1 Series

- Built-in LED illumination provides natural light across a broad area
- Lighting unit easily switched on/off. Lighting angle can also be adjusted.
- High-precision aspherical lens reduces image distortion all the way to the lens periphery
- Hard coating on the lens surfaces to prevent scratching
- Rubber material on the handle for a comfortable, secure grip
- Can be held in either the left or right hand
- Available in two types: 4D and 8D

Model name	Reading Magnifier L1 Series	
	L1-4D (Square type)	L1-8D (Round type)
Effective size/diameter of lens (mm)	100 x 54	80
Refractive power (dioptries)	4	8
Reference magnification (x)	1.5	2
Lens material	Acrylic (PMMA) lens	
Lens form	Equiconvex aspherical lens	
Surface coating	Hard coating	
Dimensions (L x W x D) (mm)	160 x 198 x 17	230 x 91 x 17
Weight (g) (without battery)	115	114
Light source	White LED x1	
Power	LR03 (AAA size) alkaline battery x 1	
Battery life (at a temperature of 25°C)*	Approx. 8 hours	

\* Battery life varies depending on temperature, humidity and other conditions.

Reference magnification is when an object is clearly visible at approx. 250mm.

## Reading Magnifier S1 Series

- High-precision aspherical lens reduces image distortion all the way to the lens periphery
- Hard coating on the lens surfaces to prevent scratching
- Rubber material on the handle for a comfortable, secure grip
- Can be held in either the left or right hand
- Available in two colours: red and blue, and three types: 4D, 8D and 10D

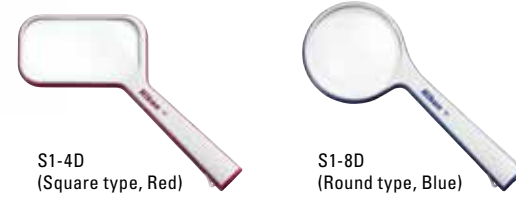

## Reading Magnifier U1-4D

- Minimises the burden on the hand and arm while holding (Universal Design)
- Handle can rotate 360 degrees and its angle can be adjusted freely
- Folding the handle enables compact storage
- High-precision aspherical lens reduces image distortion all the way to the lens periphery
- Hard coating on the lens surfaces to prevent scratching
- Can be held in either the left or right hand



## Precision Loupe (for connoisseurs)

- Superior resolution of 63 lines/mm
- Airtight retractable lens is ideal for professional tasks
- Lens comprises three optical glass elements



Model name	Reading Magnifier S1 Series		
	S1-4D (Square type)	S1-8D (Round type)	S1-10D (Round type)
Colour	Red/Blue		
Effective size/diameter of lens (mm)	100 x 54	80	60
Refractive power (dioptries)	4	8	10
Reference magnification (x)	1.5	2	2.5
Lens material	Acrylic (PMMA) lens		
Lens form	Equiconvex aspherical lens		
Surface coating	Hard coating		
Size (L x W x D) (mm)	160 x 198 x 17	230 x 91 x 17	190 x 71 x 15
Weight (g)	109	108	65

Reference magnification is when an object is clearly visible at approx. 250mm.

Model name	Reading Magnifier U1-4D
Effective size of lens (mm)	100 x 54
Refractive power (dioptries)	4
Reference magnification (x)	1.5
Lens material	Acrylic (PMMA) lens
Lens form	Equiconvex aspherical lens
Surface coating	Hard coating
Size (L x W x D) (mm)	83 x 142 (up to 242 when the handle is open) x 18
Weight (g)	103

Reference magnification is when an object is clearly visible at approx. 250mm.

Model name	Precision Loupe
Effective diameter (mm)	13
Focusing distance (mm)	25
Magnification (x)	10 (±1%)
Dimensions (L x W x H) (mm)*	42 x 24 x 16
Weight (g)	Approx. 15

\* When the lens is retracted to its original position.

# Fieldmicroscopes



EZ-Micro + FSB-UC + COOLPIX Digital Camera

## EZ-Micro

- Enables photography with a Nikon COOLPIX digital camera
- Stereoscopic observation at 20x magnification
- Made with environmentally friendly materials
- Built-in illumination system
- Exclusive compact design for easy operation



EZ-Micro

## Fieldmicroscope Fieldmicroscope Mini

- Compact, portable body
- 20x magnification
- Stereoscopic microscope
- Built-in illumination system (Fieldmicroscope)
- Water-resistant (Fieldmicroscope Mini)



Fieldmicroscope



Fieldmicroscope Mini

Model name	EZ-Micro
Magnification (x)	20 (fixed)
Optical system	Upright, unreversed image; eyepiece dioptre adjustable for both eyes; 51 to 72mm interpupillary distance adjustment
Field of vision (mm)	11 (diameter)
Angle of view (°)	12.6
Vertical adjustment	38mm from the base of stage
Photographic optical system	Collimated light beam
Photographic magnification	Varies according to the attached digital camera model [Example: at A4-size printing] Approx. 20x (at 35mm-equivalent wide angle setting) to approx. 57x (at 100mm-equivalent telephoto setting)
Eye relief (mm)	12.8
Plate	Removal and reversible (top: flat; underside: built-in cup)
Light source	Two white LEDs
Light settings	Three settings: off, one lamp, two lamps
Power source	One AA-size battery; approx. 10-hour battery life (alkaline battery at 20°C)
Dimensions (mm)	(In use) 162-202 (H) x 145 (D) x 106 (W) (Folded close) 138 (H) with lighting fitted
Weight (g)	Approx. 635 (without battery)
Filters	M37 x 0.75mm thread filters can be attached
Accessories (supplied)	Large carrying case; jointed strap

Model name	Fieldmicroscope	Fieldmicroscope Mini
Magnification (x)	20 (fixed)	
Optical system	Upright, unreversed image, eyepiece dioptre adjustable for right eye	
Interpupillary distance adjustment (mm)	56-72	51-72
Field of vision (mm)	11 (diameter)	
Angle of view (°)	12.6	
Vertical adjustment	50mm from the base of stage	42mm from the base of stage
Eye relief (mm)	11.1	12.8
Plate	Removal and reversible (top: flat; underside: built-in cup)	
Dimensions (mm)	(In use) 184-238(H) x 94(D) x 100(W) (Folded close) 144(H)	(In use) 156-202(H) x 89(D) x 90(W) (Folded close) 124(H)
Weight (g)	Approx. 610	Approx. 395
Accessories (supplied)	Soft case; head unit cover; strap	Soft case; strap



# Technical Data

Note: Apparent field of view is calculated based on the ISO 14132-1:2002 standard. For details, see p 54.

Specifications

Specifications









**EDG**

**MONARCH**

						
Model name	EDG 8x32	EDG 10x32	EDG 7x42	EDG 8x42	EDG 10x42	MONARCH 7 8x30
Magnification (x)	8	10	7	8	10	8
Objective diameter (mm)	32	32	42	42	42	30
Angular field of view (Real/degree)	7.8	6.5	8.0	7.7	6.5	8.3
Angular field of view (Apparent/degree)	57.2	59.2	52.2	56.6	59.2	60.3
Field of view at 1,000m (m)	136	114	140	135	114	145
Exit pupil (mm)	4.0	3.2	6.0	5.3	4.2	3.8
Relative brightness	16.0	10.2	36.0	28.1	17.6	14.4
Eye relief (mm)	18.5	17.3	22.1	19.3	18.0	15.1
Close focusing distance (m)	2.5	2.5	3.0	3.0	3.0	2.0
Interpupillary distance adjustment (mm)	54-76	54-76	55-76	55-76	55-76	56-72
Weight (g)	655	650	785	785	790	435
Length (mm)	138	138	149	148	151	119
Width (mm)	139	139	141	141	141	123
Depth (mm)	50	50	54	54	54	48
Type	Roof	Roof	Roof	Roof	Roof	Roof

**MONARCH**

**MONARCH**

						
Model name	MONARCH 7 10x30	MONARCH 7 8x42	MONARCH 7 10x42	MONARCH 5 8x42	MONARCH 5 10x42	MONARCH 5 12x42
Magnification (x)	10	8	10	8	10	12
Objective diameter (mm)	30	42	42	42	42	42
Angular field of view (Real/degree)	6.7	8.0	6.7	6.3	5.5	5.0
Angular field of view (Apparent/degree)	60.7	58.4	60.7	47.5	51.3	55.3
Field of view at 1,000m (m)	117	140	117	110	96	87
Exit pupil (mm)	3.0	5.3	4.2	5.3	4.2	3.5
Relative brightness	9.0	28.1	17.6	28.1	17.6	12.3
Eye relief (mm)	15.8	17.1	16.5	19.5	18.4	15.1
Close focusing distance (m)	2.0	2.5	2.5	2.5	2.5	2.5
Interpupillary distance adjustment (mm)	56-72	56-72	56-72	56-72	56-72	56-72
Weight (g)	440	650	660	590	600	600
Length (mm)	119	142	142	145	145	145
Width (mm)	123	130	130	129	129	129
Depth (mm)	48	57	57	55	55	55
Type	Roof	Roof	Roof	Roof	Roof	Roof

**MONARCH**

**PROSTAFF**

						
Model name	MONARCH 5 8x56	MONARCH 5 16x56	MONARCH 5 20x56	PROSTAFF 7S 8x30	PROSTAFF 7S 10x30	PROSTAFF 7S 8x42
Magnification (x)	8	16	20	8	10	8
Objective diameter (mm)	56	56	56	30	30	42
Angular field of view (Real/degree)	6.2	4.1	3.3	6.5	6.0	6.8
Angular field of view (Apparent/degree)	46.9	59.6	59.9	48.9	55.3	50.8
Field of view at 1,000m (m)	108	72	58	114	105	119
Exit pupil (mm)	7.0	3.5	2.8	3.8	3.0	5.3
Relative brightness	49.0	12.3	7.8	14.4	9.0	28.1
Eye relief (mm)	20.5	16.4	16.4	15.4	15.4	19.5
Close focusing distance (m)	7.0	5.0	5.0	2.5	2.5	4.0
Interpupillary distance adjustment (mm)	60-72	60-72	60-72	56-72	56-72	56-72
Weight (g)	1,140	1,230	1,235	415	420	650
Length (mm)	199	199	199	119	119	167
Width (mm)	146	146	146	123	123	129
Depth (mm)	67	67	67	49	49	55
Type	Roof	Roof	Roof	Roof	Roof	Roof



Note: Apparent field of view is calculated based on the ISO 14132-1:2002 standard. For details, see p 54.

Specifications

Specifications

**PROSTAFF 7s**



**PROSTAFF 5**



**ACULON T01**



**ACULON T01**



**ACULON T51**



**ACULON T11**



**ACULON A211**



Model name	PROSTAFF 7S 10x42	PROSTAFF 5 8x42	PROSTAFF 5 10x42	PROSTAFF 5 10x50	PROSTAFF 5 12x50	ACULON T01 8x21	ACULON T01 10x21	ACULON T51 8x24	ACULON T51 10x24	ACULON T11 8-24x25 (set at 8x)	ACULON A211 7x35	ACULON A211 8x42	ACULON A211 10x42
Magnification (x)	10	8	10	10	12	8	10	8	10	8-24	7	8	10
Objective diameter (mm)	42	42	42	50	50	21	21	24	24	25	35	42	42
Angular field of view (Real/degree)	6.2	6.3	5.6	5.6	4.7	6.3	5.0	6.2	5.3	4.6	9.3	8.0	6.0
Angular field of view (Apparent/degree)	56.9	47.5	52.1	52.1	52.4	47.5	47.2	46.9	49.7	35.6	59.3	58.4	55.3
Field of view at 1,000m (m)	108	110	98	98	82	110	87	108	93	80	163	140	105
Exit pupil (mm)	4.2	5.3	4.2	5.0	4.2	2.6	2.1	3.0	2.4	3.1	5.0	5.3	4.2
Relative brightness	17.6	28.1	17.6	25.0	17.6	6.8	4.4	9.0	5.8	9.6	25.0	28.1	17.6
Eye relief (mm)	15.5	17.5	15.2	19.6	15.5	10.3	8.3	12.2	10.6	13.0	11.8	12.0	11.6
Close focusing distance (m)	4.0	5.0	5.0	5.0	5.0	3.0	3.0	2.5	2.5	4.0	5.0	5.0	5.0
Interpupillary distance adjustment (mm)	56-72	56-72	56-72	56-72	56-72	56-72	56-72	56-72	56-72	56-72	56-72	56-72	56-72
Weight (g)	645	630	630	815	790	195	195	200	200	305	685	755	760
Length (mm)	164	165	163	187	183	87	87	103	102	123	118	145	145
Width (mm)	129	130	130	140	140	104	104	105	105	109	185	185	185
Depth (mm)	55	54	54	65	65	35	35	29	29	51	62	62	62
Type	Roof	Roof	Roof	Roof	Roof	Roof	Roof	Roof	Roof	Porro	Porro	Porro	Porro

**ACULON A211**



**ACULON A30**



**High Grade**









Model name	ACULON A211 7x50	ACULON A211 10x50	ACULON A211 12x50	ACULON A211 16x50	ACULON A211 8-18x42 (set at 8x)	ACULON A211 10-22x50 (set at 10x)	ACULON A30 8x25	ACULON A30 10x25	8x42HG L DCF	10x42HG L DCF	8x32HG L DCF	10x32HG L DCF	8x20HG L DCF
Magnification (x)	7	10	12	16	8-18	10-22	8	10	8	10	8	10	8
Objective diameter (mm)	50	50	50	50	42	50	25	25	42	42	32	32	20
Angular field of view (Real/degree)	6.4	6.5	5.2	4.2	4.6	3.8	6.0	5.0	7.0	6.0	7.8	6.5	6.8
Angular field of view (Apparent/degree)	42.7	59.2	57.2	60.8	35.6	36.7	45.5	47.2	52.1	55.3	57.2	59.2	50.8
Field of view at 1,000m (m)	112	114	91	73	80	66	105	87	122	105	136	114	119
Exit pupil (mm)	7.1	5.0	4.2	3.1	5.3	5.0	3.1	2.5	5.3	4.2	4.0	3.2	2.5
Relative brightness	50.4	25.0	17.6	9.6	28.1	25.0	9.6	6.3	28.1	17.6	16.0	10.2	6.3
Eye relief (mm)	17.6	11.8	11.5	12.6	10.3	8.6	15.0	13.0	20.0	18.5	17.0	16.0	15.0
Close focusing distance (m)	8.0	7.0	8.0	9.0	13.0	15.0	3.0	3.0	3.0	3.0	2.5	2.5	2.4
Interpupillary distance adjustment (mm)	56-72	56-72	56-72	56-72	56-72	56-72	56-72	56-72	56-72	56-72	56-72	56-72	56-72
Weight (g)	905	900	910	925	825	960	275	275	795	790	695	695	270
Length (mm)	180	179	179	179	163	197	125	122	157	157	129	129	96
Width (mm)	197	197	197	197	185	197	115 (72*)	115 (72*)	139	139	138	138	109 (65*)
Depth (mm)	68	68	68	68	61	68	44 (56*)	44 (56*)	62	62	57	57	45 (49*)
Type	Porro	Porro	Porro	Porro	Porro	Porro	Roof	Roof	Roof	Roof	Roof	Roof	Roof



Note: Apparent field of view is calculated based on the ISO 14132-1:2002 standard. For details, see p 54.











Specifications

Specifications

	High Grade	Elegant Compact				Compact		Compact					
													
Model name	10x25HG L DCF	4x10DCF	6x15M CF	7x15M CF Black	5x15 HG Monocular	7x15 HG Monocular	Sportstar EX 8x25DCF	Sportstar EX 10x25DCF	TRAVELITE EX 8x25CF	TRAVELITE EX 9x25CF	TRAVELITE EX 10x25CF	TRAVELITE EX 12x25CF	TRAVELITE VI 8x25CF
Magnification (x)	10	4	6	7	5	7	8	10	8	9	10	12	8
Objective diameter (mm)	25	10	15	15	15	15	25	25	25	25	25	25	25
Angular field of view (Real/degree)	5.4	10.0	8.0	7.0	9.0	6.6	8.2	6.5	6.3	5.6	5.0	4.2	5.6
Angular field of view (Apparent/degree)	50.5	38.6	45.5	46.4	43.0	44.0	59.7	59.2	47.5	47.5	47.2	47.5	42.7
Field of view at 1,000m (m)	94	175	140	122	157	115	143	114	110	98	87	73	98
Exit pupil (mm)	2.5	2.5	2.5	2.1	3.0	2.1	3.1	2.5	3.1	2.8	2.5	2.1	3.1
Relative brightness	6.3	6.3	6.3	4.4	9.0	4.4	9.6	6.3	9.6	7.8	6.3	4.4	9.6
Eye relief (mm)	15.0	13.7	10.1	10.0	15.8	12.0	10.0	10.0	15.5	15.8	15.9	15.9	14.0
Close focusing distance (m)	3.2	1.2	2.0	2.0	0.6	0.8	2.5	3.5	2.8	2.8	2.8	2.8	3.0
Interpupillary distance adjustment (mm)	56-72	57-72	56-72	56-72	—	—	56-72	56-72	56-72	56-72	56-72	56-72	56-72
Weight (g)	300	65	130	135	75	75	300	300	355	360	365	365	265
Length (mm)	112	52	48	47	71	71	103	103	100	101	102	103	115
Width (mm)	109 (67*)	93	108	108	30	30	114 (67*)	114 (67*)	116	116	116	116	118
Depth (mm)	45 (49*)	19	36	36	30	30	43 (54*)	43 (54*)	56	56	56	56	54
Type	Roof	Roof	Porro	Porro	Roof	Roof	Roof	Roof	Porro	Porro	Porro	Porro	Porro

\*Folded

\*Folded

	Compact	Marine				Marine		Standard					
													
Model name	TRAVELITE VI 10x25CF	TRAVELITE VI 12x25CF	7x50CF WP	7x50CF WP Compass	7x50IF WP	7x50IF WP Compass	7x50IF HP WP Tropical	10x70IF HP WP	10x50CF WP	Action EX 7x35CF	Action EX 8x40CF	Action EX 7x50CF	Action EX 10x50CF
Magnification (x)	10	12	7	7	7	7	7	10	10	7	8	7	10
Objective diameter (mm)	25	25	50	50	50	50	50	70	50	35	40	50	50
Angular field of view (Real/degree)	5.0	4.2	7.2	7.2	7.5	7.0	7.3	5.1	6.2	9.3	8.2	6.4	6.5
Angular field of view (Apparent/degree)	47.2	47.5	47.5	47.5	49.3	46.4	48.1	48.0	56.9	59.3	59.7	42.7	59.2
Field of view at 1,000m (m)	87	73	126	126	131	122	128	89	108	163	143	112	114
Exit pupil (mm)	2.5	2.1	7.1	7.1	7.1	7.1	7.1	7.0	5.0	5.0	5.0	7.1	5.0
Relative brightness	6.3	4.4	50.4	50.4	50.4	50.4	50.4	49.0	25.0	25.0	25.0	50.4	25.0
Eye relief (mm)	11.1	11.1	22.7	22.7	18.0	18.0	15.0	15.0	17.4	17.3	17.2	17.1	17.2
Close focusing distance (m)	3.0	4.0	10.0	10.0	25.0	25.0	24.5	50.0	17.0	5.0	5.0	7.0	7.0
Interpupillary distance adjustment (mm)	56-72	56-72	56-72	56-72	56-72	56-72	56-72	56-72	56-72	56-72	56-72	56-72	56-72
Weight (g)	270	275	1,100	1,120	1,170	1,210	1,360	1,985	1,065	800	855	1,000	1,020
Length (mm)	110	110	193	193	178	178	217	304	195	120	138	179	178
Width (mm)	118	118	202	202	203	203	210	234	207	184	187	196	196
Depth (mm)	54	54	71	81	71	92	80	91	71	62	63	68	68
Type	Porro	Porro	Porro	Porro	Porro	Porro	Porro	Porro	Porro	Porro	Porro	Porro	Porro

Note: Apparent field of view is calculated based on the ISO 14132-1:2002 standard. For details, see p 54.

## Standard

## The Standard for Advanced Nature Observation

Model name	Action EX 12x50CF	Action EX 16x50CF	8x30E II	10x35E II	7x50IF SP WP	10x70IF SP WP	18x70IF WP WF
Magnification (x)	12	16	8	10	7	10	18
Objective diameter (mm)	50	50	30	35	50	70	70
Angular field of view (Real/degree)	5.5	3.5	8.8	7.0	7.3	5.1	4.0
Angular field of view (Apparent/degree)	59.9	52.1	63.2	62.9	48.1	48.0	64.3
Field of view at 1,000m (m)	96	61	154	122	128	89	70
Exit pupil (mm)	4.2	3.1	3.8	3.5	7.1	7.0	3.9
Relative brightness	17.6	9.6	14.4	12.3	50.4	49.0	15.2
Eye relief (mm)	16.1	17.8	13.8	13.8	16.2	16.3	15.4
Close focusing distance (m)	7.0	7.0	3.0	5.0	12.4	25.0	81.0
Interpupillary distance adjustment (mm)	56-72	56-72	56-72	56-72	56-72	56-72	56-72
Weight (g)	1,045	1,040	575	625	1,485	2,100	2,050
Length (mm)	178	177	101	126	217	304	293
Width (mm)	196	196	181	183	210	234	234
Depth (mm)	68	68	54	54	80	91	91
Type	Porro	Porro	Porro	Porro	Porro	Porro	Porro

## Binocular Accessories

### Tripod/monopod adaptors

#### TRA-2 Usable models

- ACULON A211 series
- Action series
- Action zoom series
- Action EX series
- 7x50CF WP/7x50CF WP Compass
- 7x50IF WP/7x50IF WP Compass
- 10x50CF WP



#### TRA-3 Usable models

- EDG 8x32/10x32/7x42/8x42/10x42
- MONARCH 7 8x30/10x30/8x42/10x42
- MONARCH 5 8x42/10x42/12x42/8x56/16x56/20x56
- MONARCH 36/42/56 series
- PROSTAFF 7S 8x42/10x42
- PROSTAFF 7 8x42/10x42
- Action series
- Action zoom series
- Action EX series
- 7x50CF WP/7x50CF WP Compass
- 7x50IF WP/7x50IF WP Compass
- 10x50CF WP



#### Usable models

- 7x50IF HP WP Tropical
- 8x32SE CF/10x42SE CF/12x50SE CF
- 18x70IF WP WF
- 7x50IF SP WP/10x70IF SP WP
- 10x70IF HP WP
- 8x30E II/10x35E II



#### Adaptor H (for roof prism binoculars) Usable models

- EDG 8x32/10x32/7x42/8x42/10x42
- MONARCH 7 8x30/10x30/8x42/10x42
- MONARCH 5 8x42/10x42/12x42
- MONARCH 36/42 series
- PROSTAFF 7S 8x30/10x30/8x42/10x42
- PROSTAFF 7 8x42/10x42
- PROSTAFF 5 8x42/10x42
- 8x42HG L DCF
- 10x42HG L DCF
- 8x32HG L DCF
- 10x32HG L DCF



Hard (H) type

## Values for Apparent Field of View

With the conventional method used previously, the apparent field of view was calculated by multiplying the real field of view by the binocular magnification. After revision, Nikon's figures are now based on the ISO 14132-1:2002 standard, and obtained by the following formula:

$$\tan \omega' = \Gamma \times \tan \omega$$

Apparent field of view:  $2\omega'$   
Real field of view:  $2\omega$   
Magnification:  $\Gamma$

For example, the apparent field of view of 8x binoculars with an 8.8° real field of view is as follows:

$$2\omega' = 2 \times \tan^{-1} (\Gamma \times \tan \omega)$$

$$= 2 \times \tan^{-1} (8 \times \tan 4.4^\circ)$$

$$= 63.2^\circ$$

Referring to the ISO 14132-2:2002 standard that was established at the same time as the abovementioned ISO 14132-1:2002, binoculars that provide an apparent field of view over 60° are considered wide-viewfield binoculars.

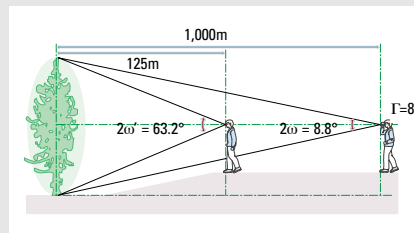

EDG Fieldscope 85 VR



EDG Fieldscope 85-A VR



EDG Fieldscope 85



EDG Fieldscope 85-A



EDG Fieldscope 65



EDG Fieldscope 65-A

## EDG VR Fieldsopes

Model name	EDG Fieldscope 85 VR	EDG Fieldscope 85-A VR
Objective diameter (mm)	85	85
Close focusing distance (m)	5.0	5.0
Length (mm)* <sup>1</sup>	379	398
Height x width (mm)* <sup>1</sup>	141 x 104	141 x 104
Weight (g)* <sup>1</sup>	2,400 (without batteries)	2,400 (without batteries)
Vibration Reduction effects at (25°C)* <sup>2</sup>	Observation: Degree of vibration is reduced to approx. 1/8 Digiscoping: Equivalent of a shutter speed approx. 2 stops faster	
Power source	AA alkaline battery x4, AA lithium battery x4 or AA Ni-MH (nickel metal hydride) battery x4	
Battery life (at 25°C)* <sup>3</sup>	Approx. 17 hours (AA alkaline battery), approx. 31 hours (AA lithium battery), approx. 15 hours (AA Ni-MH (nickel metal hydride) battery)	

\*1 Body only. \*2 Based on Nikon Fieldscope measuring standard (used with tripod). \*3 Battery life varies depending on conditions, temperature and vibration.

## EDG Fieldsopes

Model name	EDG Fieldscope 85	EDG Fieldscope 85-A	EDG Fieldscope 65	EDG Fieldscope 65-A
Objective diameter (mm)	85	85	65	65
Length (mm)*	379	398	313	332
Height x width (mm)*	127 x 102	131 x 102	120 x 88	131 x 88
Weight (g)*	2,030	2,030	1,560	1,620

\*Body only.

## Eyepieces for EDG Fieldsopes

Model name	Magnification (x)	Angular field of view (Real/degree)	Angular field of view (Apparent/degree)* <sup>2</sup>	Field of view at 1,000m (m) (approx.)	Exit pupil (mm)	Relative brightness	Eye relief (mm)	Weight (g)
FEP-20W	With EDG 65 series	16	4.1	72	4.1	16.8	20.1	240
	With EDG 85 series	20	3.3	60.0	4.3	18.5	20.1	240
FEP-30W	With EDG 65 series	24	3.0	64.3	2.7	7.3	25.4	390* <sup>1</sup>
	With EDG 85 series	30	2.4	64.3	2.8	7.8	25.4	390* <sup>1</sup>
FEP-38W	With EDG 65 series	30	2.4	64.3	2.2	4.8	17.9	230
	With EDG 85 series	38	1.9	64.3	2.2	4.8	17.9	230
FEP-50W	With EDG 65 series	40	1.8	64.3	1.6	2.6	17.8	230
	With EDG 85 series	50	1.4	64.3	1.7	2.9	17.8	230
FEP-75W	With EDG 65 series	60	1.2	64.3	1.1	1.2	17	230
	With EDG 85 series	75	1.0	64.3	1.1	1.2	17	230
FEP-25 LER	With EDG 65 series	20	3.0	55.3	3.3	10.9	32.3	320
	With EDG 85 series	25	2.4	55.3	3.4	11.6	32.3	320
FEP-20-60	With EDG 65 series	16-48	2.8-1.4	42-60	4.1-1.4	16.8-2.0	18.4-16.5	330
	With EDG 85 series	20-60	2.2-1.1	42-60	4.3-1.4	18.5-2.0	18.4-16.5	330

\*1 With detachable turn-and-slide eyepiece \*2 Apparent field of view is calculated based on the ISO 14132-1:2002 standard. For details, see p 54.



Fieldscopes



Model name	PROSTAFF 5 Fieldscope 82	PROSTAFF 5 Fieldscope 82-A	PROSTAFF 5 Fieldscope 60	PROSTAFF 5 Fieldscope 60-A	PROSTAFF 3 Fieldscope *2	Fieldscope ED50	Fieldscope ED50 A
Objective diameter (mm)	82	82	60	60	60	50	50
Length (mm)*1	377	392	290	305	313	209	207
Width (mm)*1	95	95	85	85	74	71	71
Weight (g)*1	950	960	740	750	620	455	470

\*1 Body only (except PROSTAFF 3 Fieldscope). \*2 For detailed specifications, see p 57.

Eyepieces for PROSTAFF 5 Fieldscopes

Model name	Magnification (x)	Angular field of view (Real/degree)	Angular field of view (Apparent/degree)*	Field of view at 1,000m (m) (approx.)	Exit pupil (mm)	Relative brightness	Eye relief (mm)	Weight (g)
SEP-25								
With 60/60-A	20	2.8	51.3	48	3.0	9.0	17.6	135
With 82/82-A	25	2.2	51.3	38	3.3	10.9	17.6	135
SEP-38W								
With 60/60-A	30	2.3	62.1	40	2.0	4.0	19.0	185
With 82/82-A	38	1.8	62.1	31	2.2	4.8	19.0	185
SEP-20-60								
With 60/60-A	16-48	2.6 (at 16x)	39.9 (at 16x)	45 (at 16x)	3.8 (at 16x)	14.4 (at 16x)	16.9 (at 16x)	225
With 82/82-A	20-60	2.1 (at 20x)	39.9 (at 20x)	36 (at 20x)	4.1 (at 20x)	16.8 (at 20x)	16.9 (at 20x)	225

\* Apparent field of view is calculated based on the ISO 14132-1:2002 standard. For details, see p 54.

PROSTAFF 3 Fieldscopes









Model name	Magnification (x)	Angular field of view (Real/degree)	Angular field of view (Apparent/degree)*	Field of view at 1,000m (m) (approx.)	Exit pupil (mm)	Relative brightness	Eye relief (mm)
PROSTAFF 3 Fieldscope	16-48	2.3 (at 16x)	35.6 (at 16x)	40 (at 16x)	3.8 (at 16x)	14.4 (at 16x)	19.0 (at 16x)

\* Apparent field of view is calculated based on the ISO 14132-1:2002 standard. For details, see p 54.

Eyepieces for Fieldscope ED50/ED50 A

Model name	Magnification (x)	Angular field of view (Real/degree)	Angular field of view (Apparent/degree)*3	Field of view at 1,000m (m) (approx.)	Exit pupil (mm)	Relative brightness	Eye relief (mm)	Weight (g)
13-30x/20-45x/25-56x MC zoom *1	13-30	3.0 (at 13x)	38.5 (at 13x)	52 (at 13x)	3.8 (at 13x)	14.4 (at 13x)	12.9 (at 13x)	100
13-40x/20-60x/25-75x MC II zoom *1*2 With ED50/ED50 A	13-40	3.0 (at 13x)	38.5 (at 13x)	52 (at 13x)	3.8 (at 13x)	14.4 (at 13x)	14.1 (at 13x)	150
16x/24x/30x Wide DS *1*2 With ED50/ED50 A	16	4.5	64.3	79	3.1	9.6	18.7	170
27x/40x/50x Wide DS *1*2 With ED50/ED50 A	27	2.7	64.3	47	1.9	3.6	17.8	180
40x/60x/75x Wide DS *1*2 With ED50/ED50 A	40	1.8	64.3	31	1.3	1.7	17.0	190

\*1 These eyepieces are not to be used for Fieldscope I series. \*2 Turn-and-slide rubber eyecup. \*3 Apparent field of view is calculated based on the ISO 14132-1:2002 standard. For details, see p 54.  
Note: All eyepieces can be used for Fieldscope II series, ED78 series, III series, EDIII series and ED82 series.

									
Model name	COOLSHOT AS	COOLSHOT	COOLSHOT 20	PROSTAFF 7	PROSTAFF 3i	ACULON	Laser 1000A S	Laser 1200S	Forestry Pro
Measurement range	4.5-550m/5-600 yds.	10-550m/11-600 yds.	5-500m/6-550 yds.	4.5-550m/5-600 yds.	7.3-590m/8-650 yds.	5-500m/6-550 yds.	10-915m/11-1,000 yds.	10-1,100m/11-1,200 yds.	Distance:10-500m/11-550 yds./33-999 ft.(*999 ft.: 304.5m/333 yds.) Angle: ±89°
Distance display (Increment)	Actual distance (upper 4-digit): every 0.5m/yd. Actual distance (lower 3-digit): every 1m/yd. Horizontal distance (upper 4-digit): every 0.2m/yd. Height (lower 3-digit): every 0.2m/yd. (shorter than ±100m/yds.) every 1m/yd. (±100m/yds. and over) Slope adjusted distance (Horizontal distance ±Height) (upper 4-digit): every 0.2m/yd.	Every 0.5m/yd.	Every 1m/yd.	Every 0.1m/yd.	Every 0.1 m/yd.	Every 1m/yd.	Actual Distance (upper 4-digit): every 0.5m/yd. (shorter than 1,000m/yds.) every 1m/yd. (1,000m/yds. and over) Actual Distance (lower 3-digit): every 1m/yd. (shorter than 1,000m/yds.) Horizontal Distance (upper 4-digit): every 0.2m/yd. (shorter than 1,000m/yds.) every 1m/yd. (1,000m/yds. and over) Height (lower 3-digit): every 0.2m/yd. (shorter than ±100m/yds.) every 1m/yd. (±100-999m/yds.) Slope adjusted distance (Horizontal distance ±Height) (upper 4-digit): every 0.2m/yd. (shorter than 1,000m/yds.) every 1m/yd. (1,000m/yds. and over)	Every 0.5m/yd. (shorter than 1,000m/yds.) Every 1m/yd. (1,000m/yds. and over)	[Internal Display] Act (Actual Distance): every 0.5m/yd., 1 ft. (shorter than 100m/yds./ft.) every 1m/yd./ft. (100m/yds./ft. and over) Hor (Horizontal Distance) and Hgt (Height): every 0.2m/yd., 0.5 ft. (shorter than 100m/yds./ft.) every 1m/yd./ft. (100m/yds./ft. and over) Ang (Angle): every 0.1° (less than 10°) every 1° (10° and over) *Downward angle from the horizontal line: with display "-"  [External Display] Act (Actual Distance): every 0.5m/yd., 1 ft. Hor (Horizontal Distance) and Hgt (Height): every 0.2m/yd., 0.5 ft. Ang (Angle): every 0.1°
Finder	Magnification (x) 6 Effective objective diameter (mm) 21 Actual field of view (°) 7.5 Exit pupil (mm) 3.5 Eye relief (mm) 18.3	6 21 7.5 3.5 18.3	6 20 6.0 3.3 16.7	6 21 7.5 3.5 18.3	6 21 7.5 3.5 18.3	6 20 6.0 3.3 16.7	6 21 7.5 3.5 18.3	7 25 5.0 3.6 18.6	6 21 6.0 3.5 18.2
Dimensions (L x H x W) (mm)	113 x 70 x 39	111 x 70 x 40	91 x 73 x 37	113 x 70 x 39	112 x 70 x 36	91 x 73 x 37	118 x 73 x 41	145 x 82 x 47	130 x 69 x 45
Weight (excluding battery) (g)	175	165	125	175	160	125	195	280	210
Power source	CR2 lithium battery x 1 (DC 3V) Auto power shutoff function equipped (after about 8 sec.)				CR2 lithium battery x 1 (DC3V) Auto power shutoff function equipped (after 8 sec.)				CR2 lithium battery x 1 (DC3V) Auto power shutoff function equipped (after 30 sec.)
Safety	Class 1M Laser Product (EN/IEC60825-1:2007) Class I Laser Product (FDA/21 CFR Part 1040.10:1985)				Class 1M Laser Product (EN/IEC60825-1:2007) Class I Laser Product (FDA/21 CFR Part 1040.10:1985)			Class 1M Laser product (EN/IEC60825-1:2007)	
EMC	FCC Part15 SubPartB class B, EU:EMC directive, AS/NZS, VCCI class B				FCC Part15 SubPartB class B, EU:EMC directive, AS/NZS, VCCI class B				
Environment	RoHS, WEEE				RoHS, WEEE				

The specifications of these products may not be achieved depending on the target object's shape, surface texture and nature, and/or weather conditions.

The specifications of these products may not be achieved depending on the target object's shape, surface texture and nature, and/or weather conditions.





Nikon is constantly developing new ways to prevent environmental pollution and ensure a healthier ecosystem. Back in 1998, we introduced the Nikon Basic Policy for Green Procurement, a diverse range of activities designed to reduce the environmental impact of our products. Under this policy, we employ materials, parts, and packaging items produced with special concern for the environment.

In our Environmental Action Plan for Fiscal 2005, we established the goal of completely eliminating seven harmful substances — hexavalent chrome, lead, cadmium, mercury, PBB, PBDE and polyvinyl chloride — from all Nikon consumer products by September 2005.

Nikon is also in full compliance with the EU's July 2006 RoHS (Restriction of the Use of Certain Hazardous Substances in Electrical and Electronic Equipment) directive, as well as other, newer EU regulations.

We are constantly reducing waste by implementing environmental policies that extend the life of our products and simplify repairs, while minimising energy consumption through more efficient use of power.

At Nikon, we're wholly committed to developing innovative and exciting eco-friendly products for our precious world.

Specifications and equipment are subject to change without any notice or obligation on the part of the manufacturer.  
The colour of products in this brochure may differ from the actual products due to the colour of the printing ink used.  
August 2014

©2014 NIKON VISION CO., LTD.



**WARNING**

**Never look at the sun directly through optical equipment.  
It may cause damage to or loss of eyesight.**



**NIKON VISION CO., LTD.**

Nikon Futaba Bldg., 3-25, Futaba 1-chome, Shinagawa-ku,  
Tokyo 142-0043, Japan  
Tel: +81-3-3788-7697 Fax: +81-3-3788-7698

[www.nikon.com/sportoptics](http://www.nikon.com/sportoptics)

Printed in Japan



Printed with vegetable ink.



**En**

Code No. 3CE-BQYH-7(1408-15) K